

AN  
UNLIMITED  
PROMOTIONAL  
WORLD



RECYCLED  
ALUMINIUM



**+200 NOVELTIES**

4206 CEDRO | PG.212





# INDEX

12

TECHNOLOGY

PG. 12—69

70

WRITING ¶ OFFICE

PG. 70—117

118

BAGS ¶ TRAVEL

PG. 118—191

192

EATING ¶ DRINKWARE

PG. 192—237

238

HOME/GIFTS ¶ PREMIUM

PG. 238—269

270

TOOLS ¶ PET CARE

PG. 270—287

288

WINTER ¶ RAINY DAYS

PG. 288—299

300

SUBLIMATION

PG. 300—315

316

PARTY ¶ EVENTS

PG. 316—331

332

SUMMER

PG. 332—343

344

LEISURE ¶ SPORT

PG. 344—359

360

PERSONAL CARE

PG. 360—377

378

CHRISTMAS

PG. 378—385

386

MATERIALS

PG. 386—395

396

INDEX

PG. 396—408

1216-DUMAI ◀  
PG. 364



▶ 1126-PODOX  
PG. 361

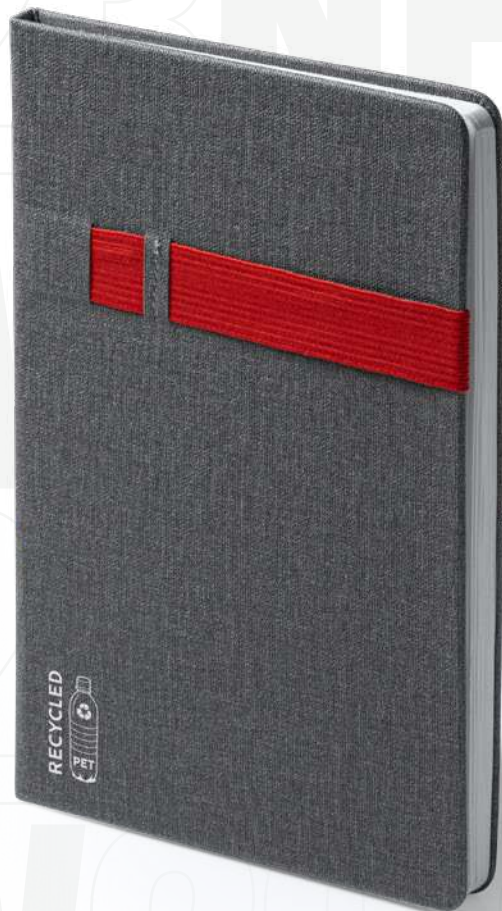

▶ 7971-SIKAS  
PG. 104



▲ 3045-FOLK  
PG. 16





**7973-ALVIK** ◀  
PG. 90



**3991-BRICO** ◀  
PG. 272



▲ **3042-TANGO**  
PG. 24



▶ **3985-TEIDE**  
PG. 203



▶ **3984-SORBY**  
PG. 271



▶ **4203-SAOKO**  
PG. 214

**7026-KARIN**  
PG. 354



▶ **4211-COIBA**  
PG. 211



**3114-KEROS**  
PG. 307



▲ **7092-AURA**  
PG. 349





**1040-VIZA**  
PG. 254



**7186-VOLANO** ◀  
PG. 120

**8105-BARI**  
PG. 333



# SERVICIO DE IMPRESIÓN

Personaliza cualquier producto con nuestro servicio exclusivo de impresión. Ponemos a tu disposición las técnicas de marcaje más avanzadas del mercado.



Impresión directa



Bordado



Serigrafía



Transfer



Láser



Sublimación



y muchas más

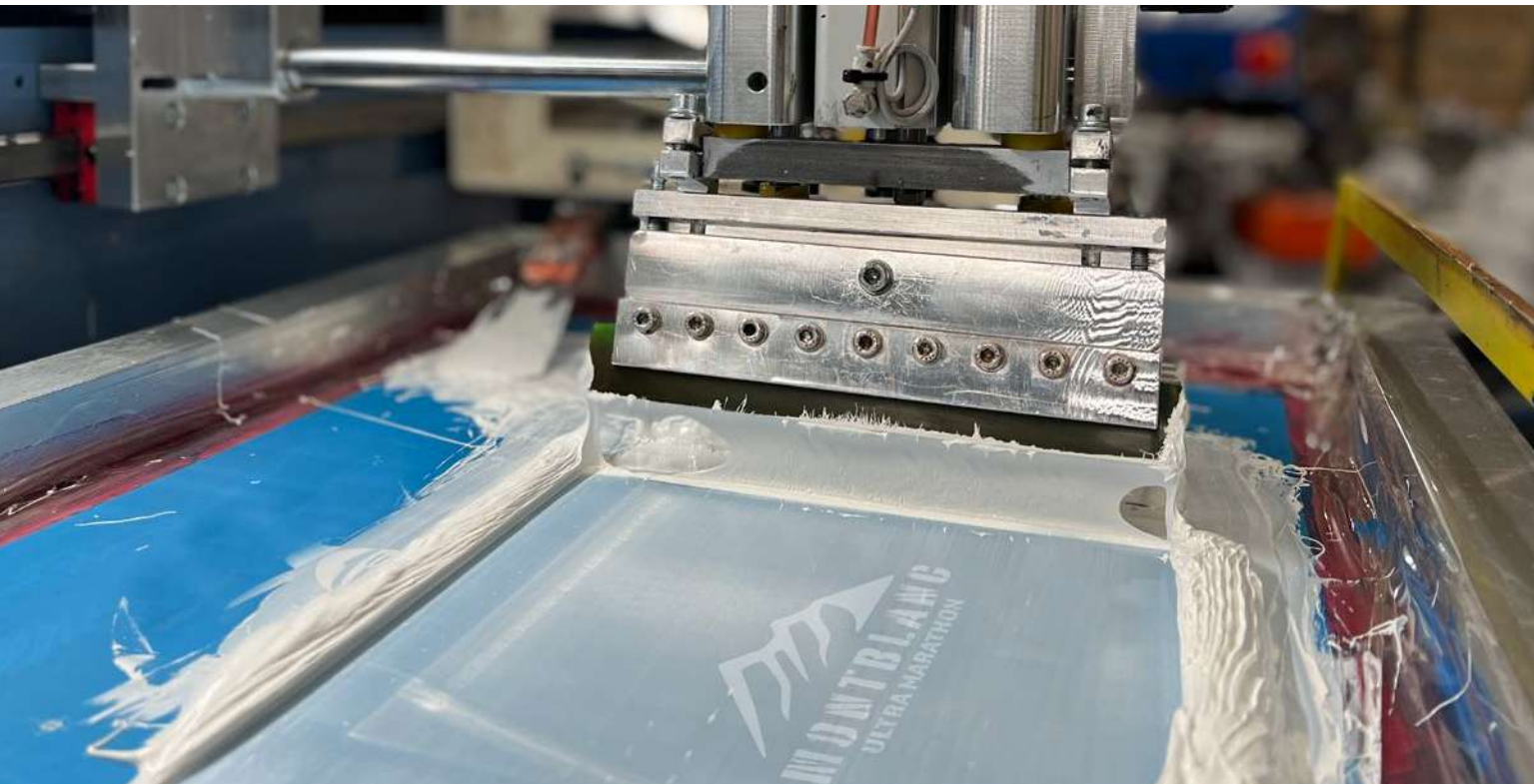

## NUESTROS CERTIFICADOS





# MATERIALES NUEVOS Y SOSTENIBLES

Ponemos a tu disposición una gran selección de productos elaborados con materiales naturales y reciclados, para contribuir con la responsabilidad de tener un mundo más sostenible.



YUTE NATURAL



BAMBÚ



CUERO RECICLADO



ALUMINIO RECICLADO



PAPEL RECICLADO



ABS RECICLADO



PET RECICLADO



FIBRA DE BAMBÚ



FIBRA DE TRIGO



TRITAN



CEMENTO



PLA



MADERA NATURAL



CORCHO NATURAL



VIDRIO DE BOROSILICATO



CÁÑAMO



ALGODÓN RECICLADO



ALGODÓN ORGÁNICO



CARTÓN RECICLADO

GUÍA DE MATERIALES PG.388

# CUIDAMOS LA PRESENTACIÓN

Una imagen vale más que mil palabras. Por ello, cuidamos hasta el más mínimo detalle en la presentación de nuestros artículos.

Aplicamos diseños exclusivos en cada uno de ellos, otorgándoles un valor único y diferente.











## EL SELLO FAIRTRADE COMERCIO JUSTO Y SOSTENIBILIDAD

La compra de productos elaborados con algodón de comercio justo certificado garantiza el apoyo de los cultivadores de algodón para que mejoren su calidad de vida y sus comunidades, contribuyendo a proteger a las personas y el medio ambiente.

Con la certificación fairtrade se pretende garantizar el cumplimiento de estándares relacionados con la producción o suministro de un producto o ingrediente. La presencia del sello significa también que el producto es totalmente rastreable (se ha mantenido aislado de los productos no certificados) desde el cultivo hasta el cliente.





MADE <sup>TO</sup> ORDER



## IT'S TIME TO DESIGN

¿Buscas un producto 100% personalizado?

Realizamos **producciones a medida en cualquier artículo**, tanto textil como de regalo.

Contamos con el equipo necesario para llevar a cabo todo tipo de proyectos.

Define el tipo de producto que necesitas y nosotros nos encargamos del resto.

**TECHNOLOGY**



# ABS RECICLADO

LÁMPARA | DESPERTADOR

NEW.

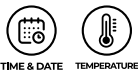

TIME &amp; DATE TEMPERATURE

## 3044 **Namur**

Lámpara despertador realizada en ABS reciclado con luz progresiva. Función de hora, fecha y temperatura. Luz led en múltiples colores. Cable incluido. Presentación en caja diseño eco.

 18,5 x 14,4 x 6,6 cm

 1/10  30

 F(4), W



NEW.

NATURAL  
CORK

BLUETOOTH



SPEAKER

FAST  
CHARGERWIRELESS  
CHARGER

TACTILE



TYPE C

2989 **Dravis**

Lámpara con detalles en corcho. Incluye cargador inalámbrico en la base de 10W y altavoz inalámbrico de 3W de potencia. Luz led con tres posiciones de iluminación. Presentación en caja diseño eco.

33 x Ø12 cm

1

20

F(1)

# CORK SPEAKER LAMP







NEW.

2987 **Yarbo**

Cargador inalámbrico con cuerpo en ABS reciclado y corcho natural. Carga rápida de 10W. Conexión Tipo C. Cable incluido. Presentación en caja diseño eco.

 10,4 x 2,1 x 10,4 cm

 1/50  100

 E(4), L2, W



# NEW FOLK



**NEW.**



NATURAL CORK



RECYCLED ABS



BLUETOOTH



HANDS FREE



TÁCTILE



TYPE C



## 3045 Folk

Auriculares inalámbricos con cuerpo en ABS reciclado y corcho natural. Estuche de carga con batería recargable. Panel de control táctil integrado en el auricular. Función manos libres. Conexión Tipo C. Cable incluido. Presentación en caja de diseño eco.

6,7 x 5 x 3 cm

1/50

100

E(4), L2, W





### 3211 **Marco**

Altavoz con cuerpo de corcho natural y membrana visible. Bluetooth 5.0. Potencia 3W. Batería recargable. Cable incluido. Presentación en caja diseño eco.

4,6 x Ø7,90 cm 1/25 50

E(4), L1

# WIRELESS CHARGING BASE



### 3031 **Sulac**

Cargador inalámbrico con cuerpo de corcho natural y fibra de trigo. 5W. Cable incluido. Presentación en caja diseño eco.

1,9 x Ø9 cm 1/50 100





E(4), L2, W



# KEVEX







CARGADOR INALÁMBRICO

-  NATURAL CORK
-  FAST CHARGER
-  WIRELESS CHARGER
-  TYPE C



## 2994 Kevex

Cargador inalámbrico con marco para fotos realizado en corcho. Ideal para fotos 10x15 cm. Compatible con dispositivos con tecnología de carga inalámbrica. 10 W. Cable incluido. Presentación en caja diseño eco.

-  17,6 x 21 cm
-  1
-  40
-  E(1), L2







-  WIRELESS CHARGER
-  NATURAL CORK



## 3032 Promet

Portalápices con cargador inalámbrico integrado. Realizado en corcho natural. Incluye 2 puertos USB adicionales en la parte trasera. 5W. Cable incluido. Presentación en caja diseño eco.

-  15,2 x 10,6 x 10,6 cm
-  1
-  20
-  F(1),L2



CARGADOR INALÁMBRICO



NATURAL  
CORK2993 **Lebak**

Alfombrilla para ratón con superficie de corcho natural y base antideslizante.

22 x 18 cm

1/100

200

E(1), L2

# LEBAK

NATURAL  
CORKWIRELESS  
CHARGER3030 **Alax**

Alfombrilla con cargador inalámbrico integrado. Suave superficie plegable de corcho natural con base antideslizante. 5W. Cable incluido. Presentación en caja diseño eco.

26 x 20,3 cm

1

50

F(1),L2

NEW.

NEWMARSAL



BAMBOO



FAST CHARGER



WIRELESS CHARGER



TYPE C



USB



2990 **Marsal**

Lámpara plegable de bambú. Incluye cargador inalámbrico de 10W integrado. 25 leds con 3 posiciones de iluminación e intensidad. Temporizador para la luz de 1 y 2 horas. Presentación en caja diseño eco.

 11 x 38,5 x 24,5 cm

 1

 20

 F(1), L2



NEW  
DESIGN  
COLLECTION



### 3016 Celsius

Estación meteorológica con carcasa frontal de bambú natural. Función reloj con sensores de temperatura y humedad. Funciona con 2 pilas AAA no incluidas. Presentación en caja diseño eco.

8,6 x 12 x 2 cm 1/25 50  
E(4),L1,W



### 3004 Kelvin

Estación meteorológica con carcasa frontal de bambú. Función reloj, calendario y alarma con sensores de temperatura y humedad. Funciona con 2 pilas AAA no incluidas. Presentación en caja diseño eco.

13 x 13 x 2,4 cm 1/20 40  
E(4),L2,W



**NEW.**

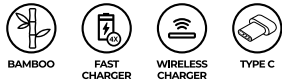

2992 **Vulco**

Cargador inalámbrico con marco para fotos realizado en bambú. Ideal para fotos 10x15 cm. Compatible con dispositivos con tecnología de carga inalámbrica. 10W. Cable incluido. Presentación en caja de diseño eco.

20,5 x 16,5 x 1,5 cm    1    40  
E(4), L2

# CLOCK & CHARGER

**NEW.**



3043 **Duncer**

Reloj con cargador inalámbrico 5W. Realizado en bambú. Funciones: hora, fecha, alarma y temperatura. Conexión Tipo C. Cable incluido. Presentación en caja diseño eco.

16 x 3,7 x 7,5 cm    1    40  
F(1), L2



ICARUS



# RELOJ CARGADOR INALÁMBRICO

WIRELESS  
CHARGER



ALARM

TIME &amp; DATE

TEMPERATURE

## 3029 Icarus

Cargador inalámbrico 5W realizado en madera MDF con función de reloj. Otras funciones: hora, fecha, alarma y temperatura. 3 modos de iluminación. Cable incluido. Presentación en caja diseño eco.

16 x 2,9 x 7,5 cm  1  50

 E(4), L2, W



NEW

BAMBOO HEADPHONES





# TANGO

HANDS  
FREE

TYPE C



BAMBOO

## 3042 **Tango**

Auriculares inalámbricos de bambú y tejido RPET. Extensibles. Diadema y almohadillas acolchadas. Panel de control integrado con tecnología estéreo. Función manos libres. Batería recargable. Cable Tipo C incluido. Presentación caja diseño eco.

 12,5 x 18 x 6,5 cm  1/15  30

 F(1), L2

# MOON



## 3197 Moon

Altavoz de diseño lunar con base realizada en madera. Función lámpara. Potencia 3W. Luz led con diferentes posiciones. Cable incluido. Presentación en caja diseño eco.

12 x 15 x 12 cm  1  20

 F(1), L2

ALTAVOZ | 3W | LUZ LED  
DIFERENTES MODOS DE LUZ

Luz fría



Luz cálida



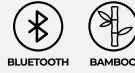

BLUETOOTH BAMBOO



### 3199 **Solum**

Altavoz inalámbrico con cuerpo de bambú. Incluye elegante asa de transporte. 3W de potencia. Batería recargable. Cable incluido. Presentación en caja diseño eco.

8,1 x Ø6,90 cm 1 50

F(4), L1

# BAMBOO SPEAKERS



BLUETOOTH BAMBOO CHANGING COLOR LIGHT



### 3195 **Ozcan**

Altavoz inalámbrico con cuerpo realizado en bambú. Luz multicolor con 4 modos. Potencia 3W. Batería recargable y cable incluido. Presentación en caja diseño eco.

10,6 x Ø6,40 cm 1/25 50

E(4), L1



BLUETOOTH HANDS FREE BAMBOO LINE IN

### 3206 **Kravis**

Altavoz inalámbrico con cuerpo de bambú y membrana visible. Ideal para marcaje en láser. Bluetooth 3.0. 3W de potencia. Batería recargable. Cable incluido. Presentación en caja diseño eco.

6 x 6 x 6 cm 1 50

E(4), L1







### 3306 **Nervo**

Altavoz inalámbrico Bluetooth con cuerpo de bambú natural. Función radio FM, manos libres, ranura para tarjeta Micro SD. 3W de potencia. Batería recargable. Cable incluido. Presentación en caja diseño eco.

5,1 x Ø6 cm 1/25 50  
E(4), L1



### 3207 **Hardwell**

Altavoz inalámbrico con cuerpo de ABS blanco y bambú natural. Función radio FM, manos libres, ranura para tarjetas micro SD y 3W de potencia. Batería recargable. Cable incluido. Presentación en caja diseño eco.

4,1 x Ø7,30 cm 1 50  
E(2), L1



### 3210 **Alesso**

Altavoz inalámbrico Bluetooth con cuerpo de ABS, frontal de bambú natural y membrana visible. Incluye asa para transporte de polipiel. 3W de potencia. Batería recargable. Cable incluido. Presentación en caja diseño eco.

7,4 x 7 x 4,5 cm 1/25 50  
E(4), L2



### 3026 **Blues**

Auriculares inalámbricos Bluetooth 5.0 con estuche de carga en bambú natural. Botón multifunción táctil integrado en ambos auriculares. Función manos libres. Batería recargable. Cable incluido. Presentación en caja diseño eco.

7,8 x 3,2 x 3,2 cm 1/50 100  
E(4), L1, W



3018 **Soyuz**

Cargador inalámbrico con cuerpo de ABS blanco y superficie superior de bambú natural. Coloque su Smartphone sobre el y déjelo cargar. Compatible con dispositivos con tecnología inalámbrica. 5W. Cable incluido. Presentación en caja diseño eco.

1 x Ø6 cm    1/50    200  
E(4), L2, W



3355 **Rossum**

Batería externa de 5000 mAh con cuerpo de ABS blanco y superficie superior de bambú. Salida corriente USB DC5V/2.1A. Incluye cable Micro USB. Presentación en caja diseño eco.

10,1 x 1,5 x 6,3 cm    1/25    50  
E(4), L2, W

# ACCESORIOS DE BAMBOO

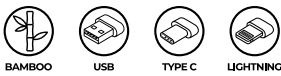

3036 **Gasly**

Llavero con cable cargador 3 en 1. Cuerpo de bambú. Conexión Micro USB, Tipo C y lightning. Presentación en bolsa eco con ventana.

4 x 0,8 x 10 cm    1/100    500  
D(4), L1, W



3019 **Astro**

Cable cargador 3 en 1. Cuerpo de ABS y bambú natural. Conexión Micro USB, Tipo C y Lightning. Presentación en bolsa eco con ventana.

16,5 x 1 x 2,1 cm    1/100    400  
D(1), L1



BAMBOO



USB

### 3023 Neptune

Puerto USB con cuerpo de bambú natural y cable en blanco. Incluye 3 puertos USB. Presentación en caja de diseño eco.

8,5 x 1,6 x 4 cm 1/50 200

D(4), L1, W

BAMBOO POWERBANK



CARGADOR INALÁMBRICO

TIPO C



BAMBOO



WIRELESS CHARGER



TYPE C



USB



### 3349 Misty

Batería externa de 6000 mAh con función carga inalámbrica. Cuerpo de bambú natural. Salida corriente DC5V/2.1A, inalámbrica DC5V. Incluye cable tipo C. Presentación en caja diseño eco.

7,5 x 14,5 x 1,6 cm

1/20

40

E(4), L2, W







CARGA INALÁMBRICA

# BAMBOO COLLECTION



BAMBOO

WIRELESS  
CHARGER

## 3024 Core

Cargador inalámbrico de bambú natural integrado en bandeja organizadora. Compatible con dispositivos con tecnología de carga inalámbrica. 5W. Cable blanco incluido. Presentación en caja diseño eco.

27 x 1,5 x 14,5 cm 1 20

E(1), L2, W



2 PUERTOS USB 3.0



BAMBOO

WIRELESS  
CHARGER

USB



TYPE C



## 3001 Nebula

Cargador inalámbrico con cuerpo de bambú natural. Capacidad de carga de hasta 3 dispositivos simultáneamente. Compatible con modelos con tecnología de carga inalámbrica. Tipo C. 5W. Salida corriente USB DC5V/2.1A. Presentación en caja diseño eco.

9 x 1 x 9 cm 1/25 50

E(4), L2, W



BAMBOO



WIRELESS CHARGER

### 3022 Gravity

Cargador inalámbrico con cuerpo de bambú natural. Coloque su Smartphone sobre él y déjelo cargar. Compatible con dispositivos con tecnología inalámbrica. 5W. Cable incluido. Presentación en caja diseño eco.

7 x 11,5 x 8 cm 1/25 50

E(4), L2

CARGADOR INALÁMBRICO



# ECO DESIGN



BAMBOO



WIRELESS CHARGER



### 3027 Gamma

Cargador inalámbrico con soporte para móviles y tablets realizado en bambú natural. 5W. Cable de 1m incluido. Presentación en caja diseño eco.

12,5 x 8 x 1,6 cm 1/50 100

E(4), L2, W

CARGADOR INALÁMBRICO





### 3055 **Antix**

Soporte para dispositivos móviles, tablet o smartphone, realizado en bambú natural.

 6 x 2 x 8 cm

 1/50

 200

 D(4), L1, W

# BAMBOO HOLDERS



### 3010 **Lyra**

Soporte de bambú natural para móviles. Ranura inferior para cable de carga. Incluye 2 partes de fácil montaje.

 8 x 8,1 x 12 cm

 1/50

 100

 D(4), L2, W





**NEW.**



3194 **Takay**

Altavoz inalámbrico con cuerpo de bambú y tejido RPET. 3W de potencia y batería recargable. Conexión Tipo C. Cable incluido. Presentación en caja diseño eco.

5,3 x Ø6 cm    1/25    50  
 F(1), L2



3193 **Bemol**

Altavoz inalámbrico con cuerpo de bambú y tejido RPET. Potencia 3W y batería recargable. Conexión Tipo C. Cable incluido. Presentación en caja diseño eco.

9,5 x 9,5 x 5,2 cm    1/10    30  
 F(1), L2

**NEW.**



# NEW BEMOL

**NEW.**

BAMBOO

RECYCLED  
PETFAST  
CHARGERWIRELESS  
CHARGER

TYPE C

**2988 Sibon**

Cargador inalámbrico con cuerpo de bambú y tejido RPET. Compatible con modelos con tecnología de carga inalámbrica. Salida 10W. Conexión Tipo C. Cable incluido. Presentación en caja diseño eco.

0,8 x Ø9,80 cm 1/50 100

F(1), L2

# RPET + BAMBOO

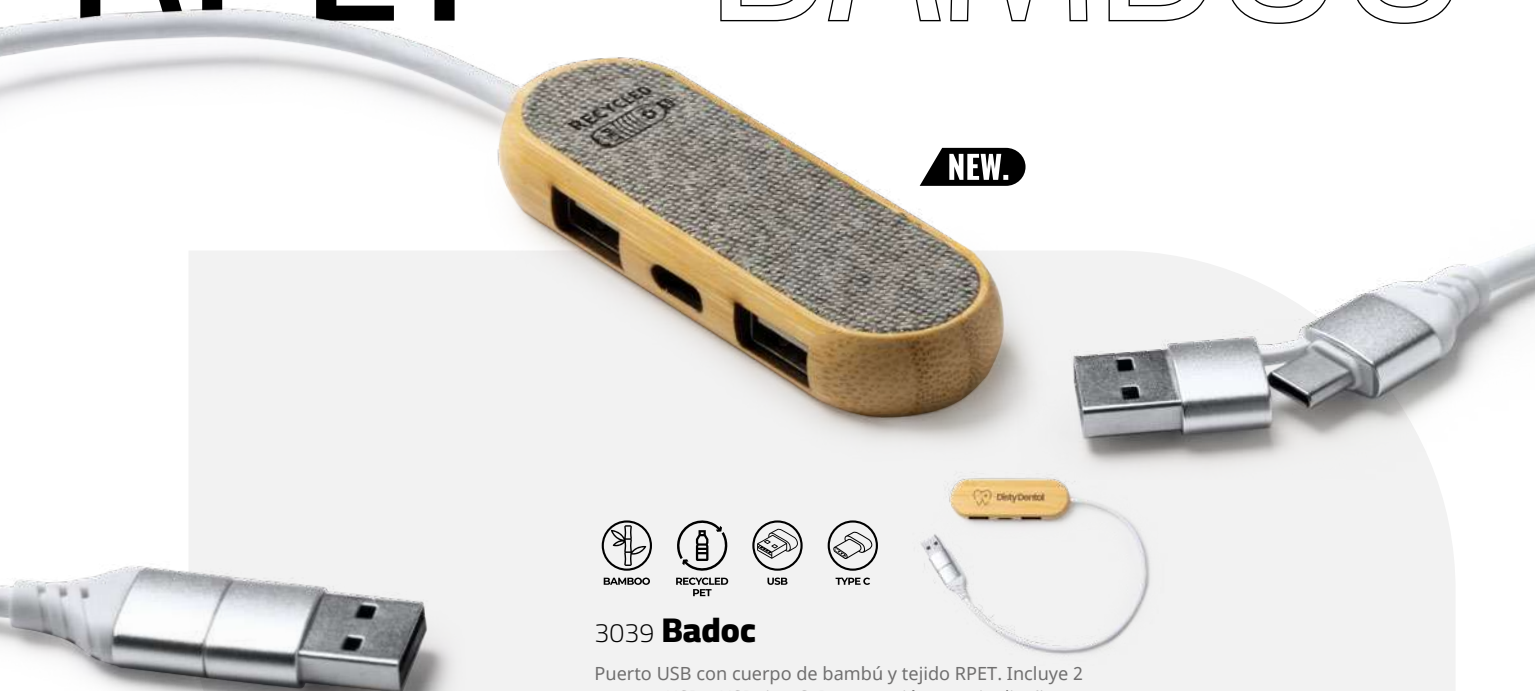
**NEW.**

BAMBOO

RECYCLED  
PET

USB



TYPE C

**3039 Badoc**

Puerto USB con cuerpo de bambú y tejido RPET. Incluye 2 puertos USB y USB tipo C. Presentación en caja diseño eco.

8,2 x 1,2 x 2,6 cm 1/50 200

E(1), L2





# CEMENT COLLECTION





### 3021 Mars

Cargador inalámbrico con cuerpo de bambú natural y base de cemento piedra caliza. Coloque su Smartphone sobre el y déjelo cargar. Compatible con dispositivos con tecnología inalámbrica. 5W. Cable incluido. Presentación en caja diseño eco.

9,4 x 12,5 x 9,4 cm

1/15 30

E(1), L2



### 3209 Heldens

Altavoz Bluetooth con base de carga inalámbrica y membrana visible. Cuerpo de cemento piedra caliza y superficie de bambú natural. 5W de potencia de altavoz y salida inalámbrica de 5W. Batería recargable. Cable incluido. Presentación en caja diseño eco.

11,8 x 7,8 x 6,5 cm

1/10 20

F(4), L2



### 3208 Steve

Altavoz inalámbrico con cuerpo de cemento piedra caliza y superficie de bambú natural. Bluetooth 5.0. 3W de potencia y batería recargable. Cable incluido. Presentación en caja diseño eco.

7,2 x Ø7 cm

1/15 30

E(4), L2



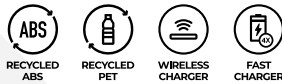

2999 **Zibal**

Cargador inalámbrico con cuerpo en ABS reciclado y superficie superior en tejido RPET. Coloque su smartphone sobre él y déjelo cargar. Compatible con modelos de tecnología inalámbrica 10W. Incluye cable micro USB. Presentación en caja diseño eco.

Ø10 cm  
E(1), W

1/50 100

# ABS RECYCLADO + RPET

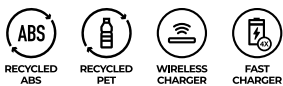

3356 **Dilbar**

Batería externa de 8000 mAh con cuerpo de ABS reciclado y superficie superior en tejido RPET. Salida de corriente USB DC5V/2.1A. Inalámbrica 10W. Incluye cable Micro USB. Presentación en caja diseño eco.

13,5 x 1,5 x 7,1 cm

1/20 40

F(1), N(8)





3311 **Elson**

Altavoz inalámbrico con cuerpo de ABS reciclado. Bluetooth 5.0. Potencia 3W. Batería recargable. Cable incluido. Presentación en caja diseño eco.

6,2 x Ø6,20 cm 1/25 50

E(1)



LUZ LED

ELSON

VAIDI



TÁCTIL



3312 **Valdi**

Auriculares inalámbricos Bluetooth 5.0 con estuche de carga. Realizados en ABS reciclado y superficie superior de bambú. Panel de control con tecnología táctil integrada en auricular. Función manos libres. Estuche con batería recargable y tapa imantada. Cable Micro USB incluido. Presentación en caja diseño eco.

6,5 x 2,6 x 3,6 cm 1 50

E(4), L1, W



# NEW DEMAR

NEW.



- RECYCLED PET
- WIRELESS CHARGER
- FAST CHARGER
- TYPE C



## 3038 Demar

Alfombrilla para escritorio de RPET con cargador inalámbrico (10W). Incluye soportes para teléfono y bolígrafo. Presentación en caja diseño eco.

31 x 0,8 x 27 cm 1/10 20

F(1), N(8)

RECYCLED  
PETWIRELESS  
CHARGER

BLUETOOTH

HANDS  
FREE

TYPE C



### 3192 **Tenor**

Altavoz inalámbrico con tejido RPET y base de carga inalámbrica (5W). Potencia 3W. Conexión Tipo C. Cable incluido. Presentación en caja diseño eco.

8 x Ø9,30 cm 1/10 30

F(1)

**NEW.**

# BLUETOOTH SPEAKER

RECYCLED  
PET

BLUETOOTH

HANDS  
FREE

### 3310 **Custik**

Altavoz inalámbrico con cuerpo tejido en RPET con membrana visible. Bluetooth 5.0. Potencia 3W. Batería recargable. Cable incluido. Presentación en caja diseño eco.

4,6 x Ø7,90 cm 1/25 50

F(4)



DCSV





TÁCTIL

- WHEAT FIBER
- BAMBOO
- BLUETOOTH
- HANDS FREE
- TACTILE
- TYPE C

### 3041 Kuasi

Auriculares inalámbricos de fibra de trigo y bambú con estuche de carga. Panel de control con tecnología táctil integrada. Función manos libres. Batería recargable. Cable Tipo C incluido. Presentación en caja diseño eco.

3,9 x 2,3 x 3,7 cm 1/50 200

E(4), W



ESTUCHE DE CARGA

TÁCTIL

- WHEAT FIBER
- BLUETOOTH
- HANDS FREE
- TACTILE

### 3309 Burak

Auriculares inalámbricos Bluetooth 5.0 realizados en fibra de trigo con estuche de carga. Panel de control con tecnología táctil integrado en auricular. Función manos libres. Estuche con batería recargable y tapa imantada. Cable incluido. Presentación en caja diseño eco.

6,8 x 2,2 x 4,5 cm 1/50 100

E(4), W

# FAST CHARGER



- WHEAT FIBER
- BAMBOO
- BLUETOOTH
- HANDS FREE
- WIRELESS CHARGER
- FAST CHARGER

### 3308 Zatox

Altavoz bluetooth con base de carga inalámbrica. Cuerpo de fibra de trigo y superficie de bambú natural. 5W de potencia y salida inalámbrica de 5W. Batería recargable. Presentación en caja diseño eco.

16 x 6 x 7,8 cm 1/15 30

F(4), L2



# NORBY

WHEAT FIBER | FOLDABLE | HANDS FREE

# HEADPHONES



## 3035 **Norby**

Auriculares inalámbricos realizados en fibra de trigo.  
Acolchado superior y almohadillas en polipiel. Plegables.  
Panel de control integrado con tecnología estéreo.  
Función manos libres y radio FM. Batería Recargable.  
Cable incluido. Presentación en caja diseño eco.

17 x 7,5 x 18,5 cm 1/10 20

F(1)



### 3198 **Kumber**

Altavoz inalámbrico realizado en fibra de trigo. Función radio FM, tarjeta micro SD y manos libres. 3w de potencia. Cable incluido. Presentación en caja diseño eco.

5 x Ø6 cm   1/25   50  
E(4)



### 2996 **Vatox**

Base de carga inalámbrica realizada en fibra de trigo. Compatible con dispositivos con tecnología de carga inalámbrica. 5W. Incluye cable micro USB. Presentación en caja diseño eco.

1 x Ø7 cm   1/50   100  
E(4), W



### 3057 **Bawen**

Soporte para móvil plegable hecho en fibra de trigo con bordes antideslizantes.

8,8 x 8,8 x 3 cm   1/100   500  
B(4), W



# WHEAT FIBER LINE

PLASTICS REDUCTION



WHEAT  
FIBER



USB

## 3034 Gospek

Puerto USB HUB realizado en fibra de trigo. Incluye 4 puertos USB. Presentación en caja diseño eco.

1,8 x Ø5,20 cm 1/50 200

D(4), W



WHEAT  
FIBER



WIRELESS  
CHARGER



USB



## 2995 Melbux

Lapicero multifunción realizado en fibra de trigo. Incluye soporte para Smartphone, cargador inalámbrico 5 W y tres puertos USB. Cable micro USB incluido. Presentación en caja diseño eco.

8,5 x 9 x 10 cm 1/25 50

E(1), W





# UMEK

10W | PREMIUM FABRIC | LED LIGHTS



BLUETOOTH

HANDS  
FREE

TYPE C

CHANGING  
COLOR LIGHT

LINE IN

## 3196 Umek

Altavoz inalámbrico de diseño con acabado tejido premium. Membrana transparente con 6 modos de luz led. Potencia 10W. Conexión Tipo C. Incluye resistente asa de transporte y placa especial para marcaje láser. Batería recargable de larga duración. Cable incluido. Presentación en caja diseño.

18,5 x Ø7,50 cm 1/10 20

F(1), L2



BLUETOOTH

HANDS  
FREEWIRELESS  
CHARGERWATER  
RESIST

LINE IN



TYPE C

### 3191 **Sakura**

Altavoz powerbank con función de carga inalámbrica de 5W. Potencia 10W. Resistencia al agua IPX7. Conexión Tipo C. Cable incluido. Presentación en caja diseño.

 19,9 x 8,5 x 9,1 cm

 1/5

 10

 F(1), W



LUZ LED



### 3203 **Vandik**

Altavoz inalámbrico Bluetooth 5.0 en acabado blanco con tacto goma. Combinación con tela a color. Panel de control táctil y luz LED multicolor en la base, con iluminación aleatoria al ritmo de la música. Función manos libres. 3W de potencia. Batería recargable. Cable incluido. Presentación en caja diseño.

10,6 x Ø7,10 cm 1 50  
E(1)



### 3204 **Armin**

Altavoz inalámbrico Bluetooth bicolor. Cuerpo en acabado mate de tacto goma. Asa de transporte, botones y tela a juego. 3W de potencia. Batería recargable. Cable incluido. Presentación en caja diseño.

11,1 x 8,3 x 4,1 cm 1 50  
E(1)







VENTOSA



### 3202 Calvin

Altavoz inalámbrico con cuerpo de ABS resistente a las salpicaduras de agua. Fijación mediante ventosa. Función manos libres. 3W de potencia. Batería recargable mediante cable Micro USB. Cable incluido. Presentación en caja diseño.

5,5 x Ø8,50 cm 1 50  
F(1)

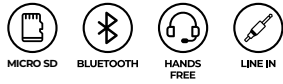

### 3200 Cox

Altavoz inalámbrico de ABS con acabado en tacto suave. Bluetooth 3.0. 3W de potencia. Función manos libres. Batería recargable. Cable incluido. Presentación en caja diseño.

7,5 x Ø6 cm 1 50  
F(1)



MICRO SD



### 3201 Garrix

Altavoz inalámbrico con cuerpo metálico en acabado mate. Bluetooth 3.0. Función radio FM y manos libres. 3W de potencia. Batería recargable. Cable incluido. Presentación en caja diseño.

5 x Ø5,90 cm 1/25 50  
E(4), L1





**WIRELESS EARPHONES**  
BLUETOOTH | FOLDABLE



RADIO FM

MICRO SD

BLUETOOTH

HANDS FREE

LINE IN

### 3150 **Legrand**

Auriculares inalámbricos Bluetooth 5.0 con acabado en tacto goma. Plegables. Acolchado superior y almohadillas en polipiel suave. Laterales en aluminio ideales para marcaje en láser. Panel de control integrado con tecnología estéreo. Función manos libres y radio FM. Batería recargable. Cable incluido. Presentación en caja blanca con fajín de diseño.

19 x 18,5 x 7,7 cm 1/10 20

F(1), L2

# LEGRAND



60



05



02



01



RADIO FM

MICRO SD

BLUETOOTH

HANDS FREE

LINE IN

### 3151 **Rayel**

Auriculares inalámbricos Bluetooth 5.0 con acabado en tacto goma. Plegables. Acolchado superior y almohadillas en polipiel suave. Laterales en aluminio ideales para marcaje en láser. Panel de control integrado con tecnología estéreo. Función manos libres y radio FM. Batería recargable. Cable incluido. Presentación en caja diseño.

19 x 17,5 x 8 cm 1/10 20

F(1)

PLEGABLE



# NEW TACET

NOISE CANCELLING | BLUETOOTH



NEW.



BLUETOOTH



HANDS  
FREE



TYPE C



TACTILE

## 3040 Tacet

Auriculares inalámbricos con cancelación de ruido. Panel de control con tecnología táctil integrado. Función manos libres. Estuche de carga con batería recargable y conexión Tipo C. Cable incluido. Presentación en caja diseño.

5,9 x 5,3 x 2,9 cm 1/50 100

E(4), W





# NEW COSTEN



## 3037 Costen

Auriculares inalámbricos con estuche de carga. Panel de control con tecnología táctil integrado. Función manos libres. Batería recargable con conexión Tipo C. Cable incluido. Presentación en caja diseño.

4,6 x 4,6 x 2,3 cm 1/50 100  
E(4), W



# FUNK



PANTALLA LCD



ESTUCHE DE CARGA

## 3307 Funk

Auriculares inalámbricos Bluetooth 5.0 con estuche de carga. Pantalla LED en el estuche y botón multifunción integrado en ambos auriculares. Función manos libres. Estuche con diseño en acabado mate y batería recargable. Cable incluido. Presentación en caja diseño.

6,2 x 2,8 x 4 cm 1/50 100  
E(4), W

TECNOLOGÍA DE CARGA INALÁMBRICA



## 3025 Trap

Auriculares inalámbricos Bluetooth 5.0 con estuche de carga. Botón multifunción integrado en ambos auriculares. Función manos libres. Batería recargable mediante tecnología inalámbrica. Cable incluido. Presentación en caja diseño.

7,5 x 3,2 x 3,2 cm 1/50 100  
E(4), W

TÁCTIL

ESTUCHE DE CARGA

BLUETOOTH  
 HANDS FREE  
 WHEAT FIBER  
 STEREO SOUND  
 TACTILE

3309 **Burak**

Auriculares inalámbricos Bluetooth 5.0 realizados en fibra de trigo con estuche de carga. Panel de control con tecnología táctil integrado en auricular. Función manos libres. Estuche con batería recargable y tapa imantada. Cable incluido. Presentación en caja diseño eco.

6,8 x 2,2 x 4,5 cm  
 1/50  
 100

E(4), W

ESTUCHE DE CARGA

TÁCTIL

BLUETOOTH  
 HANDS FREE  
 STEREO SOUND  
 TACTILE

3305 **Ferry**

Auriculares inalámbricos Bluetooth 5.0 con estuche de carga. Elegante acabado en blanco brillante. Panel de control con tecnología táctil integrado en auricular. Función manos libres. Estuche con batería recargable y tapa imantada. Cable incluido. Presentación en caja diseño.

6,8 x 2,2 x 4,5 cm  
 1/50  
 100

E(4), W

# BLUETOOTH EARPHONES + CHARGING CASE

ESTUCHE DE CARGA

TÁCTIL

- BLUETOOTH  
 HANDS FREE  
 BAMBOO  
 STEREO SOUND  
 TACTILE

## 3026 **Blues**

Auriculares inalámbricos Bluetooth 5.0 con estuche de carga en bambú natural. Botón multifunción táctil integrado en ambos auriculares. Función manos libres. Batería recargable. Cable incluido. Presentación en caja diseño eco.

7,8 x 3,2 x 3,2 cm  
 1/50  
 100

E(4), L1, W



### 3302 **Kura**

Auriculares inalámbricos con panel de control y micrófono incorporado. Sonido estéreo. Presentación en un práctico estuche de polipiel con cremallera. Batería recargable. Cable incluido.

3,9 x Ø8 cm

1/50

200

E(1), G(4)



01



02



# EARPHONES



01

03



31

60



05

226



02

40



01



60



05



02

### 3301 **Punk**

Auriculares presentados en práctica funda transparente de PVC con autocierre. Conexión Jack 3,5 mm. Cable con botón de seguridad incluido.

8 x 7,8 x 1,2 cm 1/50 500

E(1)

### 3300 **Aoki**

Auriculares en estuche de PS. Conexión Jack 3,5 mm. Cable con botón de seguridad incluido. Incluye 3 pares de fundas de diferentes medidas.

7 x 7 x 2 cm 1/50 500

D(1), W



# MULTI FUCTION SMART WATCHES



DRACO\_3401

WILLMAN\_3402

NORA\_3405



- BLUETOOTH
- CALORIES COUNTER
- PEDOMETER
- SLEEP CONTROL
- MESSAGE NOTIFY
- HEART RATE MONITOR
- APP
- REMOTE CAMERA

### 3401 Draco

Reloj inteligente con funciones de actividad. Cuerpo en TPU y pantalla a color TFT. Correa ajustable de silicona y hebilla metálica. Monitorización de frecuencia cardíaca. Conexión Bluetooth con APP para iOS y Android. Cable USB de carga incluido. Presentación en caja diseño.

- 26 x 1,9 x 1,2 cm
- 1/50
- 100
- I(1), L2

- BLUETOOTH
- CALORIES COUNTER
- PEDOMETER
- SLEEP CONTROL
- MESSAGE NOTIFY
- HEART RATE MONITOR
- APP
- REMOTE CAMERA

### 3402 Willman

Reloj inteligente con funciones de actividad. Cuerpo en TPU y pantalla a color TFT 1,3" con USB de carga integrado. Correa ajustable de silicona y hebilla metálica. Monitorización de frecuencia cardíaca. Conexión Bluetooth con APP para iOS y Android. Presentación en caja diseño.

- 25 x 1,1 x 3,4 cm
- 1
- 50
- I(1), L2

- BLUETOOTH
- CALORIES COUNTER
- PEDOMETER
- SLEEP CONTROL
- HEART RATE MONITOR
- STOPWATCH
- APP
- BLOOD PRESSURE
- MUSIC PLAYER
- PHONE CALLS
- OXYGEN PRESSURE
- TACTILE

### 3405 Nora

Reloj inteligente con funciones de actividad. Correa de TPU ajustable y pantalla IPS táctil. Monitorización de frecuencia cardíaca y control de llamadas. Conexión Bluetooth con APP para iOS y Android. Cable USB de carga incluido. Presentación en caja diseño.

- 27 x 1,2 x 3,9 cm
- 1
- 50
- I(1), L2



### 2100 **Discovery**

Cámara deportiva con tecnología de vídeo HD 4K y conexión Wi-Fi. Pantalla LCD 2" con función cámara de fotos Full HD 1080P. Incluye resistente carcasa sumergible hasta 30 m y diversos accesorios de acople multifunción. Batería extraíble recargable. Cable incluido. Presentación en caja diseño.

6 x 4,2 x 3 cm    1    20  
 K(4)



4K CAMERA  
**DISCOVERY**

**DROIDE**



01    03    60    05    02    226    0

ZONA DE IMPRESIÓN



### 3354 **Droide**

Batería externa solar de 4000 mAh. Indicador de carga LED y luz. Salida de corriente 5W/2.1A. Incluye cable Micro USB. Presentación en caja diseño.

7,5 x 14,5 x 1,5 cm    1/20    40  
 E(2)

MOSQUETÓN INCLUIDO





ESPECIAL PARA IMPRESIÓN DIGITAL

10000 mAh



0101

6001

0501

22601

### 3352 Robbie

Batería externa de ABS bicolor con 10000 mAh. Indicador de carga LED. Salida de corriente DC5V/2.1A. Incluye cable Micro USB. Presentación en caja diseño.

14,4 x 1,4 x 7,7 cm

1/10

40

E(4), W



2600 mAh



01

60

05

251

02

### 3350 Bender

Batería externa de aluminio con capacidad 2600 mAh. Indicador de carga LED. Incluye cable con conexión USB y Micro USB. Presentación en caja diseño.

9,4 x 2,1 x 2,2 cm

1/25

100

D(4), L1, W

# EXTERNAL BATTERY



VENTOSAS



ESPECIAL PARA IMPRESIÓN DIGITAL



5000 mAh

### 3353 Hal

Batería externa de ABS para carga inalámbrica con 5000 mAh. Función de fijación mediante ventosas. Indicador de carga LED. Salida corriente USB DC5V/2.1A. Inalámbrica DC5V/1A. Incluye cable Micro USB. Presentación en caja diseño.

10,4 x 6,5 x 1,6 cm

1/25

50

F(4), W



5000 mAh

### 3355 Rossum

Batería externa de 5000 mAh con cuerpo de ABS blanco y superficie superior de bambú. Salida corriente USB DC5V/2.1A. Incluye cable Micro USB. Presentación en caja diseño eco.

10,1 x 1,5 x 6,3 cm

1/25

50

E(4), L2, W



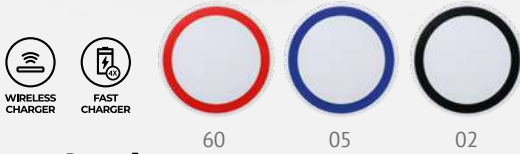

### 3003 Lander

Base de carga inalámbrica para Smartphone. Conéctela, coloque su smartphone sobre ella y déjelo cargar. Compatible con dispositivos con tecnología de carga inalámbrica. 10W. Cable incluido. Presentación en caja diseño.

1 x Ø7 cm 1/50 200  
E(4), W



### 3018 Soyuz

Cargador inalámbrico con cuerpo de ABS blanco y superficie superior de bambú natural. Coloque su Smartphone sobre el y déjelo cargar. Compatible con dispositivos con tecnología inalámbrica. 5W. Cable incluido. Presentación en caja diseño eco.

1 x Ø6 cm 1/50 200  
E(4), L2, W



### 2996 Vatox

Base de carga inalámbrica realizada en fibra de trigo. Compatible con dispositivos con tecnología de carga inalámbrica. 5W. Incluye cable micro USB. Presentación en caja diseño eco.

1 x Ø7 cm 1/50 100  
E(4), W



ALUMINIO



### 3005 Falcon

Cargador inalámbrico 10W con cuerpo en aluminio. Conéctelo, coloque su Smartphone sobre el y déjelo cargar. Una luz le indicará que está cargando. Compatible con dispositivos con tecnología de carga inalámbrica. DC5V/1.0A. Cable incluido. Presentación en caja diseño.

7 x Ø9,80 cm 1/50 100  
E(1), L1, W



### 3033 Plerion



Puerto USB con cuerpo en aluminio, acabado bicolor y cable blanco. Incluye 4 puertos USB. Presentación en caja blanca.

8,9 x 3,7 x 2,1 cm 1/50 200

D(4), L1



### 3023 Neptune

Puerto USB con cuerpo de bambú natural y cable en blanco. Incluye 3 puertos USB. Presentación en caja de diseño eco.

8,5 x 1,6 x 4 cm 1/50 200

D(4), L1, W



**NEW.**



### 3039 Badoc

Puerto USB con cuerpo de bambú y tejido RPET. Incluye 2 puertos USB y USB tipo C. Presentación en caja diseño eco.

8,2 x 1,2 x 2,6 cm 1/50 200

E(1), L2



### 3019 Astro

Cable cargador 3 en 1. Cuerpo de ABS y bambú natural. Conexión Micro USB, Tipo C y Lightning. Presentación en bolsa eco con ventana.

16,5 x 1 x 2,1 cm 1/100 400

D(1), L1





2 ACCESORIOS

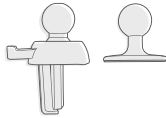

### 3054 Hydra

Soporte de coche para Smartphone con cargador inalámbrico. Conectelo, coloque el móvil sobre él y deje que se cargue. Compatible con dispositivos con tecnología de carga inalámbrica. Cable y 2 accesorios incluidos. DC5V/1.0A. Presentación en caja diseño.

8,5 x 10 x 9,4 cm 1 50  
E(1)



60 05 02 01



### 3000 Tardis

Set de cargadores USB, coche y pared, presentados en estuche de PU con cremallera. Velocidad de carga 1000 mAh.

8 x 4,2 x 6,3 cm 1/50 200  
C(4), E(1)



01 02

### 3013 Bopp

Adaptador de viaje universal de diseño compacto y retráctil, con acabado mate y tacto suave. Válido para su uso en europa, asia, reino unido, estados unidos y australia. 2 puertos USB. Velocidad de carga 2100 mAh. Presentación en caja blanca.

6,1 x 5,6 x 4,5 cm 1/50 100  
D(1), W



60 60



05 02

### 3014 Gordon

Adaptador de viaje universal. Válido para su uso en europa, asia, reino unido, estados unidos y australia. Presentación en caja blanca.

8,2 x Ø4,50 cm 1/50 100  
D(4)





3010 **Lyra**

Soporte de bambú natural para móviles. Ranura inferior para cable de carga. Incluye 2 partes de fácil montaje.

8 x 8,1 x 12 cm 1/50 100

D(4), L2, W



3055 **Antix**

Soporte para dispositivos móviles, tablet o smartphone, realizado en bambú natural.

6 x 2 x 8 cm 1/50 200

D(4), L1, W



3056 **Kunir**

Soporte para móvil plegable con topes antideslizantes.

8,8 x 8,8 x 3 cm 1/100 500

B(4), W



3057 **Bawen**

Soporte para móvil plegable hecho en fibra de trigo con topes antideslizantes.

8,8 x 8,8 x 3 cm 1/100 500

B(4), W

SUBLIMACIÓN



### 2998 **Sonic**

Alfombrilla de escritorio tamaño XL. Superficie de suave poliéster especial para sublimar y base antideslizante. Presentación individual.

70 x 35 cm

1/10

30

F(1), R



# ALFOMBRILLAS PARA RATÓN

SUBLIMACIÓN



01



60



05



02

### 2997 **Yuba**

Alfombrilla para ratón de formato redondo. Superficie de suave poliéster y base antideslizante.

Ø20 cm

1/100

200

E(1), N(8), R



# SONIC MOUSE PAD

EXTRA LARGE | SPECIAL FOR SUBLIMATION

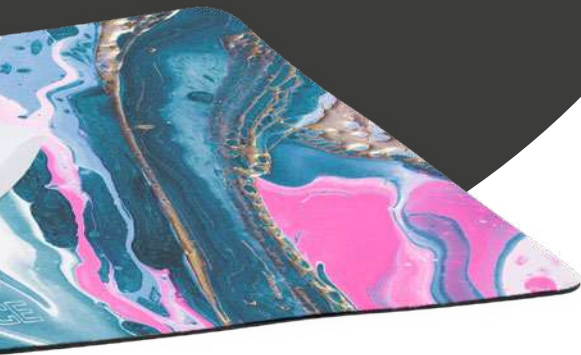

## SUBLIMACIÓN



01

03

60

05

226

02

## 3011 Sira

Alfombrilla para ratón de diseño plano. Superficie de poliéster suave y base antideslizante de goma.

22 x 18 cm

1/100

200

E(1), N(8), R



01



60



05



02

## 3012 Silvano

Alfombrilla para ratón realizada en poliéster suave con reposamuñecas acolchado. Base antideslizante de goma.

20,5 x 24,3 x 2 cm

1

100

E(1), N(8), R



ACOLCHADO



# NEW REMY

BAMBOO | RECYCLED ABS



## 3049 **Remy**

Ratón inalámbrico realizado en bambú y ABS reciclado con sensor óptico de precisión. Funciona con 2 pilas AA no incluidas. Presentación en caja diseño eco.

 10,2 x 3,4 x 5,8 cm  1/50  200

 E (1), W



### 3050 **Kasper**

Tapa para cámara de dispositivo móvil o webcam, con mecanismo deslizante y adhesivo 3M reutilizable.

3,2 x 1,3 x 0,1 cm 100 10000

B(1), W



### 3052 **Jerry**

Ratón plegable inalámbrico con sensor óptico de precisión. Diseño ergonómico con superficie en tacto goma. 2 pilas AAA no incluidas. Presentación en caja blanca.

10,8 x 3,6 x 6 cm 1/50 100

E(1), W



PLEGABLE



### 3051 **Stuart**

Ratón inalámbrico con sensor óptico de precisión y botón DPI integrado. Superficie con acabado en tacto goma. 2 pilas AAA no incluidas. Presentación en caja blanca.

11,2 x 2,4 x 5,7 cm 1/100 200

E(4), W

# USB STOCK

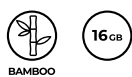

4189 **Percy**

Memoria USB con cuerpo y clip giratorio de bambú natural. Presentación en caja eco.

6,3 x 3,2 x 1,3 cm 1/50 300

D(4), L1



4190 **Uldon**

Memoria USB con cuerpo en bambú natural y clip giratorio metálico. Presentación en caja eco.

5,7 x 2 x 1,2 cm 1/50 300

D(4), L1



4196 **Vibo**

Memoria USB de cartón reciclado y clip giratorio metálico. Presentación en caja diseño eco.

5,8 x 2 x 1 cm 1/50 500

D(4), L1



4194 **Venak**

Memoria USB de fibra de trigo y clip giratorio metálico. Presentación en caja diseño eco.

5,7 x 1,9 x 0,9 cm 1/50 500

D(4), L1



4193 **Kinnox**

Memoria USB con cuerpo y clip giratorio de fibra de trigo. Presentación en caja diseño eco.

5,9 x 1,7 x 0,9 cm 1/50 500

D(4), W



# USBSTOCK



NEW.



16 GB

BAMBOO



## 4191 Gudar

Memoria USB con cuerpo de bambú natural. Presentado en caja diseño eco.

6,4 x 2,2 x 1,3 cm 1/50 500

D(4), L1, W



NEW.



16 GB

BAMBOO



## 4198 Netix

Memoria USB con cuerpo de bambú. Presentación en caja diseño eco.

5,8 x 1,4 x 0,6 cm 1/50 500

D(4), L1, W



NEW.



16 GB

NATURAL WOOD



## 4197 Ledes

Memoria USB de cartón reciclado con funda de corcho natural. Presentación en caja diseño eco.

7 x 2,9 x 0,5 cm 1/50 500

D(4), L1, W



NEW.

16 GB

## 4195 Viken

Memoria USB cilíndrica en cartón reciclado. Presentación en caja diseño eco.

6,7 x Ø1,8 cm 1/50 500

D(4), W

# USBSTOCK

NEW.



16CB

## 4192 Riot

Memoria USB con cuerpo de ABS y clip giratorio metálico a juego. Presentación en caja con ventana.

5,7 x 0,9 x 1,9 cm 1/50 500

D(4), L1

16CB

32CB



## 4188 Roy

Memoria USB metálica de diseño ultra compacto. Presentación en caja de cartón blanco mate.

3,8 x 0,4 x 1,2 cm 1/100 1000

D(4), L1

# USB FLASH DRIVES



16CB

32CB

## 4186 Marvin

Memoria USB de diseño clásico con cuerpo de ABS y clip giratorio metálico. Presentación en caja de cartón blanco mate con ventana.

5,7 x 0,9 x 1,9 cm 1/50 300

D(4), L1

16CB



## 4187 Cylon

Memoria USB de aluminio con diseño extraplano en forma de llave. Presentación en estuche metálico con ventana.

5,7 x 0,3 x 2,4 cm 1 200

D(4), L1

# USB 2023

## MADE TO ORDER



## SOLICITE NUESTRA TARIFA SEMANAL

Modelos con hasta 64Gb de capacidad. Modelos OTG, Conexión 3.0. Diseños personalizados en 2D y 3D.  
Presupuestos en 24-48h.



Caja presentación estándar gratis



Servicio de grabación de ficheros



Color pantone especial gratuito  
a partir de 500 unidades\*  
(\*Consultar modelos disponibles)



# WRITING & OFFICE

FE



7993 **Reydon** 

Elegante set compuesto por roller y portaminas de mecanismo giratorio. Realizados en metal de diseño oscurecido. Presentación en estuche de polipiel acolchado con forro interior. Tinta Azul.

 13,6 x Ø1,10 cm  1/25  50



 C(1), D(4), L1





7991 **Alton** 

Bolígrafo giratorio con cuerpo de corcho natural y metal con detalles cromados. Tinta azul. Presentación en caja de diseño eco.

 13,6 x Ø1,10 cm  1/50  300

 B(4), L1







# CORK PENS



8044 **Artur** 

Elegante bolígrafo metálico con acabado cromado y empuñadura de corcho. Presentación en estuche de corcho. Carga jumbo metálica de tinta azul.



 13,9 x Ø1,10 cm  1  200

 D(1), L1



7992 **Suver** 

Roller realizado en corcho natural y metal. Presentación en elegante estuche combinado en corcho con interior acolchado. Tinta azul.

 13,8 x Ø1,10 cm  1/50  100

 C(1), D(4), L1







BAMBOO



8041 **Bodoni**

Bolígrafo giratorio realizado en bambú con detalles metálicos. Presentado en estuche de bambú con cierre magnético. Tinta azul.

17,5 x 2,5 x 5,7 cm

1/25 100

D(4), L2



# BAMBOO PENS

PORTAMINAS



BAMBOO

8036 **Kioto**

Set de bolígrafo y portaminas en bambú, con mecanismo pulsador y tinta azul. Presentación en caja de cartón efecto madera.

17 x 2,2 x 4,1 cm 20

200

C(4), D(4), L1



8093 **Besky**

Bolígrafo con cuerpo de bambú y pulsador en acabado metalizado. Carga jumbo de tinta azul.

14 x Ø1,10 cm 1/50 1000

B(4)



8018 **Tucuma**

8019 **Pampa**

7986 **Davos**

**NEW.**

# BAMBOO LINE



BAMBOO

## 8018 **Tucuma**

Bolígrafo de bambú natural con accesorios de diseño, en acabado plateado y tinta azul.

 13,9 x Ø1,10 cm  1/50  1000

 B(4), L1



BAMBOO



TOUCH PEN

## 8019 **Pampa**

Bolígrafo de bambú natural con clip metálico, puntero táctil y carga jumbo de tinta azul.

 14,8 x Ø1 cm  1/50  1000

 B(4), L1



BAMBOO

## 7986 **Davos**

Bolígrafo de bambú con pulsador y accesorios metálicos. Tinta azul.

 13,8 x Ø1,10 cm  1/50  1000

 B(4), L1

8034 **Stoa**

8080 **Gildon**

8084 **Nagoya**



2929 0329 3129 6029 24229 11429



8034 **Stoa**

Bolígrafo pulsador con cuerpo de bambú y accesorios en fibra de trigo / ABS. Tinta azul.

14,1 x Ø1 cm 1/50 1000  
 B(4), L1

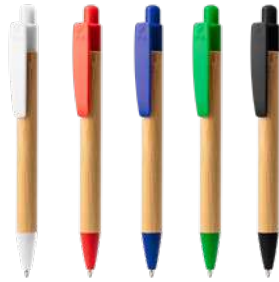

01 60 05 226 02



8080 **Gildon**

Bolígrafo con cuerpo de bambú y PLA. Tinta azul.

14 x Ø1 cm 50 1000  
 B(4), L1



29 03 60 114 242 02



8084 **Nagoya**

Bolígrafo pulsador con cuerpo de bambú, accesorios en fibra de bambú y clip metálico. Carga jumbo. Incluye puntero táctil. Tinta azul.

14 x Ø1,50 cm 1/50 1000  
 B(4), L1



NEW.



BAMBOO

7982 **Penta** 

Bolígrafo metálico en acabado mate con empuñadura de bambú y detalles en color oscuro. Tinta azul.

 14,3 x Ø1 cm  1/50  1000

 B(4), L1



01 31 49 71 242 226 02

# NEW PENS

NEW.



BAMBOO

7990 **Olten** 

Bolígrafo metálico en acabado mate con empuñadura de bambú y puntero táctil. Tinta azul.

 14,5 x Ø1 cm  1/50  500

 B(4), L1



01 55 47 02

# NEW ROLLER PIRGO

**NEW.**



BAMBOO

## 7983 **Pirgo**

Bolígrafo tipo roller con cuerpo de bambú y detalles metalizados. Carga jumbo de tinta azul.

 13,8 x Ø1,10 cm  1/50  1000

 B(4),L1



01 03 60 05 226 02



01 03 60 05 02



## 8017 **Coloma**

Bolígrafo tipo roller con cuerpo en ABS de tácto suave. Clip y punta metálicos. Carga jumbo de tinta azul.

 14,3 x Ø1,10 cm  1/50  1000

 A(4)

## 8021 **Yama**

Bolígrafo tipo roller con clip metálico, detalles en acabado plata y carga jumbo de tinta azul.

 13,5 x Ø1,10 cm  1/50  1000

 A(4)



8076 **Conwi**

8009 **Merlin**

8031 **Sagano**

8025 **Lika**

8028 **Gorbea**







251 29



8025 **Lika** 





Bolígrafo giratorio de fibra de trigo y PP con acabados en negro. Tinta azul.

 14 x Ø1,30 cm  1/50  1000  
 A(4)



8031 **Sagano** 

Bolígrafo con pulsador realizado en bambú. Carga jumbo de tinta azul.

 14 x Ø1,30 cm  1/50  1000  
 A(4), L1



8028 **Gorbea** 

Bolígrafo con pulsador de fibra de trigo y ABS. Tinta azul.

 14 x Ø1,30 cm  1/50  1000  
 A(4)





01 03 31 60 40 05 242 114 226 02



01 03 31 60 40 05 226 02





8009 **Merlin** 

Bolígrafo de ABS con pulsador y suave agarre. Tinta azul.

 14 x Ø1,30 cm  1/50  1000  
 A(4)

8076 **Conwi** 

Bolígrafo con cuerpo de ABS plateado y suave agarre de color translúcido. Tinta negra.

 14 x Ø1,30 cm  1/50  1000  
 A(4)



**+ antibacterial**  
ISO 22196



01



03 31 60 05 226 02



01 60 05 02



antibacterial  
ISO 22196

**8038 Newton** 

Bolígrafo con cuerpo de ABS anti-bacterias y tinta azul. Norma ISO 22196:2011.

 14 x Ø1,30 cm  1/50  1000

 A(4)



antibacterial  
ISO 22196

**8039 Carrel** 

Bolígrafo con cuerpo de ABS anti-bacterias y suave agarre de color translúcido. Tinta azul. Norma ISO 22196:2011.

 14 x Ø1,30 cm  1/50  1000

 A(4)



antibacterial  
ISO 22196



TOUCH PEN

**8022 Farber** 

Bolígrafo higienizante anti-bacterias multifunción, con pulverizador recargable y puntero táctil. 3 ml de capacidad (líquido no incluido). Tinta azul.

 16 x Ø1,50 cm  1/50  1000

 B(4)



8040 Stark

8045 Hindres

8010 Stix

8035 Kamut



03 31 60 05 114 226 40 02

### 8045 Hindres

Bolígrafo de ABS con pulsador. Cuerpo en color blanco y clip en variada gama de colores. Tinta azul.

13,8 x Ø1 cm 1/50 1000  
A(4)



01 03 31 60 05 226 40 02 114 242 48 63

### 8010 Stix

Bolígrafo de ABS con pulsador en variada gama de colores. Disponible en tinta azul y negra.

13,8 x Ø1 cm 1/50 1000  
A(4)

**+ antibacterial**  
ISO 22196

+ anti bacterial  
ISO 22196

### 8040 Stark

Bolígrafo con cuerpo de ABS anti-bacterias. Tinta azul. Norma ISO 22196.

13,8 x Ø1 cm 1/50 1000  
A(4)



29 03 31 60 242 114

### 8035 Kamut

Bolígrafo con pulsador realizado en fibra de trigo y ABS. Tinta azul.

13,8 x Ø1 cm 50 1000  
A(4)



8096 **Dante** 

Bolígrafo de ABS con pulsador. Cuerpo en variada gama de colores con cómoda empuñadura. Detalles en negro y metalizados. Tinta azul.

 13,8 x Ø1 cm

 1/50

 1000

 A(4)



01 03 31 60 05 226 02

8099 **Citix** 

Bolígrafo con pulsador y punta a juego en acabado bicolor. Tinta azul.

 14 x Ø1,10 cm

 1/50

 1000

 A(4)

CITIX & DANTE



# MISMO DISEÑO DISTINTA CONSCIENCIA



**FIBRATRIGO**



8032 Hana



8008 Ontario

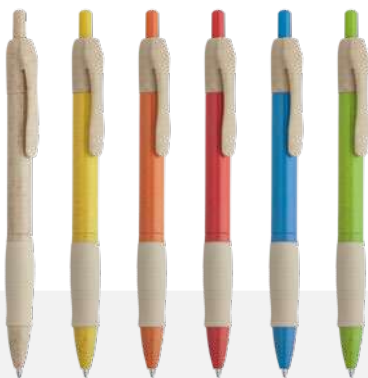

29 03 31 60 242 114





01 03 31 60 40 05 242 226 02



WHEAT  
FIBER

## 8032 Hana

Bolígrafo pulsador de fibra de trigo y ABS con cómoda empuñadura. Tinta azul.

 14,5 x Ø1 cm  1/50  1000

 A(4)

## 8008 Ontario

Bolígrafo con pulsador en acabado translúcido y cómoda empuñadura a juego. Tinta azul.

 14,5 x Ø1 cm  1/50  1000

 A(4)

# 100% ECOFRIENDLY



## 8029 Grove

Bolígrafo pulsador hecho en cartón reciclado, con la punta y el clip en fibra de trigo y ABS. Tinta azul.

14 x Ø1 cm 50 1000  
A(4), W

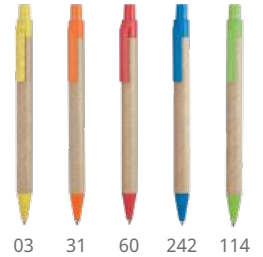

03 31 60 242 114



29 6029 24229 0229



## 8079 Alder

Bolígrafo con cuerpo de cartón reciclado y PLA. Tinta azul.

13,9 x Ø0,90 cm 50 1000  
A(4), W



01 60 05 226 02

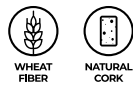

## 8043 Comper

Bolígrafo línea eco con cuerpo de corcho y detalles en fibra de trigo. Tinta azul.

14 x Ø1 cm 1/50 1000  
A(4)



29 60 242 114 02



## 8042 Liande

Bolígrafo de cartón reciclado con capucha. Tinta azul.

14,2 x Ø0,80 cm 50 1000  
A(4), W



01 03 60 05 226 29

# 100% RPET

HECHO A PARTIR DE PLÁSTICOS RECICLADOS

8048 **Arashi**



03 31 49



## 8048 **Arashi**

Bolígrafo marcador 2 en 1 con diseño translúcido, realizado a partir de material RPET. Bolígrafo de tinta azul. Marcador en colores fluor.

 14,6 x Ø1,30 cm  1/50  1000

 A(4)

8033 **Pacific**



00 31 60 242 05 226 02

## 8033 **Pacific**

Bolígrafo de diseño translúcido realizado a partir de material RPET. Mecanismo pulsador. Tinta azul.

 14,2 x Ø1,10 cm  50  1000

 A(4)



# ESTILO Y COLOR



60 05 251 02

## 8012 **Dormitur**

Bolígrafo giratorio de ABS en acabado metalizado. Tinta azul.

 15 x Ø1,10 cm  1/50  1000

 A(4)



8012 **Dormitur**

8011 **Irati**

8006 **Semenik**



0201 0203 0231 0260 0205 02226

## 8011 **Irati**

Bolígrafo giratorio de ABS en acabado brillo bicolor. Tinta azul.

 14,5 x Ø1 cm  1/50  1000

 A(4)



31 60 05 226 251 02

## 8006 **Semenik**

Bolígrafo giratorio en ABS con puntero táctil. Acabado metalizado. Tinta azul.

 13,5 x Ø1 cm  1/50  1000

 A(4)



TOUCH PEN

4 COLORES

3 COLORES

# MULTI COLOUR PENS



60 05 226 02



60 05 251

## 8094 **Kunoy**



Bolígrafo de 4 tintas con pulsador retráctil. Cuerpo de ABS con suave agarre de color. Tintas azul, negra, roja y verde.

14,1 x Ø1,30 cm 1/50 1000

A(4)

## 8098 **Sandur**



Bolígrafo de 3 tintas con pulsador retráctil. Cuerpo en ABS y detalles en negro con cómoda empuñadura. Tintas azul, negra y roja.

14,8 x Ø1,10 cm 1/50 500

A(4)

# SPECIAL FOR LASER



ESPECIAL PARA GRABADO LÁSER



01 60 05 55 226 02

## 8095 **Dover**

Bolígrafo con pulsador y cuerpo metálico de tacto suave. Punta, clip y pulsador en metal cromado. Tinta Azul. Especial para marcaje láser.

13,7 x Ø1 cm 1/50 500  
B(4), L1



8014 **Borneo**

8004 **Canaima**

8005 **Baume**



01 03 60 05 226 02

## 8014 **Borneo**



Bolígrafo metálico con pulsador, puntero táctil y clip de diseño. Carga jumbo de tinta azul.

14,8 x Ø1 cm 50 500  
B(4), L1



01 03 31 60 40 05 226 02

## 8004 **Canaima**



Bolígrafo giratorio de aluminio con puntero táctil. Tinta azul.

12,5 x Ø0,90 cm 1/100 1000  
B(4), L1



01 03 31 60 05 226 251 02

## 8005 **Baume**



Bolígrafo giratorio de aluminio con puntero táctil en color a juego con el cuerpo. Tinta azul.

13,7 x Ø0,70 cm 1/100 1000  
B(4), L1





29



BAMBOO

8093 **Besky** 

Bolígrafo con cuerpo de bambú y pulsador en acabado metalizado. Carga jumbo de tinta azul.

 14 x Ø1,10 cm  1/50  1000

 B(4)





29 03 31 60 242 114



WHEAT FIBER

8030 **Hayedo** 

Bolígrafo pulsador de fibra de trigo y ABS con acabados plateados. Tinta azul.

 14,1 x Ø1 cm  1/50  1000

 A(4)

SAME DESIGN | DIFFERENT FINISHING TOUCHES



01 60 05 226 251 02

8013 **Ardenes** 

Bolígrafo con cuerpo de aluminio y pulsador en acabado anodizado. Carga jumbo de tinta azul.

 13,7 x Ø1 cm  1/50  500

 B(4), L1

TACTO SUAVE



01 03 60 05 226 02

8078 **Norfolk** 

Bolígrafo con cuerpo metálico de tacto suave y pulsador en acabado anodizado. Punta, clip y detalles en metal cromado. Carga jumbo de tinta negra.

 13,6 x Ø1 cm  1/50  500

 B(4), L1



# METALLIC COLOURS



TOUCH PEN

## 8090 **Kruger**

Bolígrafo con cuerpo de aluminio y pulsador en acabado anodizado. Puntero táctil y carga Jumbo de tinta azul.

 13,9 x Ø1 cm     1/50     500

 B(4), L1

**+ antibacterial**  
ISO 22196



antibacterial  
ISO 22196



TOUCH PEN

## 8015 **Hallerbos**

Bolígrafo con cuerpo de ABS anti-bacterias, puntero táctil, clip metálico y carga jumbo de tinta azul. Norma ISO 22196.

 13,9 x Ø1 cm     1/50     1000

 A(4)

RECYCLED ALUMINUM



# NEW ALVIK

NEW.



7973 **Alvik** 

Elegante bolígrafo giratorio con cuerpo de aluminio reciclado y detalles metalizados. Carga jumbo de tinta azul.

 14,2 x Ø1,10 cm  1/50  500

 B(4), L1



# NEW SIMON

RECYCLED ALUMINIUM

NEW.



7972 **Simon** 

Bolígrafo con cuerpo de aluminio reciclado y pulsador en acabado anodizado. Carga jumbo de tinta azul.

 14 x Ø1 cm

 1/50

 500

 B(4), L1

# NEW ALVOR



NEW.



55 47 02

7975 **Alvor**

Funda de antelina para bolígrafo.

 15,5 x 2,5 cm

 10/200

 6000

 B(1)



01 29 02

7995 **Burton**

Funda de cartón con ventana para bolígrafo.

 4 x 15,5 cm

 50/400

 4000

 B(4)

PERPETUAL PENCIL

# NEW

# TURIN



NEW.



251 02

## 7976 Turin

Lápiz con cuerpo de aluminio. Punta de grafito de escritura infinita intercambiable. No es necesario sacarle punta. Presentación en caja eco.

 15 x Ø0,80 cm  1/50  500

 B(4), L1



**NEW.**



WHEAT FIBER



RECYCLED PAPER

7981 **Muret**

Lápiz infinito con cuerpo de cartón y fibra de trigo. Punta de grafito de escritura infinita, no es necesario sacarle punta.

14 x Ø0,80 cm

50

1000

A(4)

# PERPETUAL PENCILS



29



29



BAMBOO



7999 **Tikun**

Lápiz infinito con cuerpo de bambú. Punta de grafito de escritura infinita, no es necesario sacarle punta, incluye borrador.

15 x Ø0,80 cm

1/50

1000

A(4), L1



BAMBOO

7998 **Bakan**

Lápiz infinito con cuerpo de bambú. Punta de grafito de escritura infinita, no es necesario sacarle punta.

15 x Ø0,80 cm

1/50

1000

A(4), L1



7999 **Tikun**

7998 **Bakan**



# MULTIHERRAMIENTA



01 60 05 251 02

## 8024 **Kanchan**

Bolígrafo multiherramienta 4 en 1: nivel, regla en centímetros y pulgadas, destornillador con cabeza plana y estrella. Cuerpo con acabado metalizado, mecanismo giratorio y clip metálico. Tinta azul.

 14,9 x Ø1 cm  1/50  1000

 B(4)

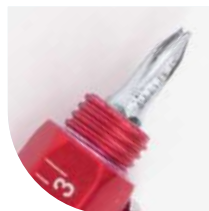
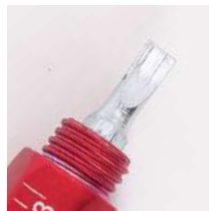

60 05 251 02

## 8023 **Araya**

Bolígrafo linterna de luz LED con cuerpo de ABS metalizado. Mosquetón integrado en la capucha. Tinta azul.

 11 x Ø1 cm  1/50  500

 B(4)



# LÁPIZ CARPINTERO



## 8088 Veta

Lápiz de carpintero en forma ovalada para un fácil marcaje. Punta sin afilar.

17,6 x 1,2 cm 100 1000

A(4), L1

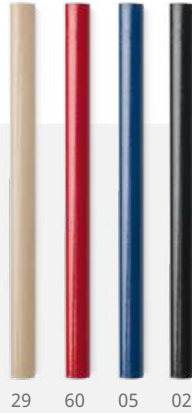

29 60 05 02

## 8003 Mata

Mini lápiz de madera en acabado natural con goma. Cuerpo redondo.

10 x Ø0,50 cm 100 2000

A(4)



01 29 03 31 60 40 05 55 226 02

## 8002 Couvet

Lápiz redondo de madera con goma.

18,6 x Ø0,70 cm 100 2000

A(4), L1



## + antibacterial ISO 22196



01 03 31 40 60 05 226



## 8046 Gryfin

Lápiz de madera con tratamiento anti-bacterias y goma disponible en varios colores.

18,6 x Ø0,70 cm 100 2000

A(4)





### 8049 Tilos

Set infantil para colorear. Incluye bloc con dibujos, 6 lápices de colores y sacapuntas. Presentación en caja de cartón reciclado.

7,4 x 1,5 x 9 cm 1/50 400

C(4), W

# COLOUR AND FUN



### 8077 Pyrus

Set infantil para colorear. Incluye bloc con dibujos variados de 36 hojas con 12 lápices de colores.

10 x 1 x 9,5 cm 1/50 200

C(4)

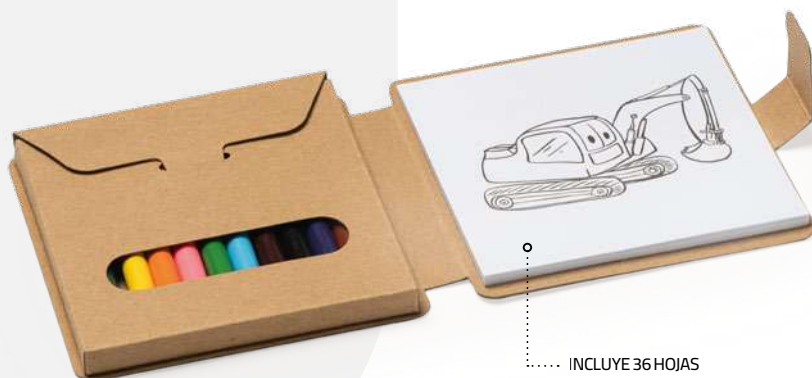

### 8069 Resol

Set infantil para colorear. Incluye bloc con dibujos variados, 6 lápices de colores, sacapuntas y goma de borrar. Práctica asa de transporte.

20 x 21 x 1,6 cm 1/40 80

D(1)





**NEW.**



**7571 Solaz**

Estuche infantil de non-woven con diseño para colorear. Incluye 5 ceras de colores variados.

22 x 11 cm 1/50 200  
F(1)



**8087 Vernak**

Set de escritura de madera natural presentado en estuche de cartón kraft. Incluye regla, 3 lápices, 1 goma de borrar y 1 sacapuntas.

17,7 x 1,3 x 4,5 cm 1/20 240  
B(4), W

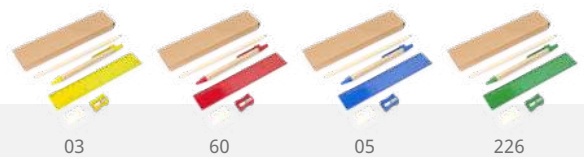

**8064 Lizana**



Set de 5 piezas presentadas en estuche de cartón kraft. Incluye bolígrafo con cuerpo de cartón y tinta azul, lápiz de madera, sacapuntas, goma y regla de 15 cm.

17,7 x 1,5 x 4,5 cm 1/50 400  
B(4), W

# NEW YAMBI

NEW.



## 7989 Yambi

Set de 4 tizas gruesas. Colores azul, rojo, verde y amarillo. Presentación en caja eco.

10,5 x 9,5 x 2,5 cm

1/50

100

B(4)



## 8092 Waldo

Set para colorear de 13 piezas. Incluye 6 ceras, 6 lápices de madera y sacapuntas. Presentación en estuche de cartón.

10 x Ø4,60 cm

10

200

B(4), W



## 8000 Boreal

Set de 6 ceras en caja de cartón reciclado.

5 x 8,3 x 0,8 cm

1/50

400

B(4), W



### 8001 Amazonia

Set de 6 lápices de madera en caja de cartón reciclado.

4,5 x 9 x 0,8 cm 25 500

B(4), W



### 7996 Koel

Set de 12 lápices de madera en caja de cartón reciclado.

9 x 9 cm 25 250

B(4), W



03 60

05 226

### 8089 Mabel

Set de 6 lápices de madera en estuche de cartón reciclado y capucha translúcida de color. Incluye sacapuntas integrado en la capucha.

10,2 x Ø2,70 cm 1/50 400

B(4), W



### 7997 Denok

Set de 3 lápices de madera en caja de cartón reciclado.

2,4 x 9 x 0,8 cm 50 1000

B(4), W

PENCIL SET



NEW.



NATURAL CORK

# NEW BALOK

MÚLTIPLES BOLSILLOS | A4 | CIERRE MAGNÉTICO



NATURAL  
CORK

## 7985 Balok

Carpeta A4 multiusos de corcho natural con cierre magnético. Incluye bloc extraíble de 30 hojas a una raya, 4 compartimentos interiores y soporte para bolígrafo.

 24,5 x 31 x 1,5 cm  1

 20

 F(1), L2

**NEW.**



**NEW/SAMAR**



255



58



02



7984 **Samar**

Carpeta A4 multiusos de RPET 600D vigoré con cierre magnético. Incluye bloc extraíble de 30 hojas a una raya. 4 compartimentos interiores y soporte para bolígrafo.

24,5 x 31 x 1,5 cm 1

20

G(1), N(8)





# RECYCLED CARDBOARD

NEW.



## 7980 **Yasper**

Carpeta de cartón reciclado. Incluye bloc extraíble de 20 hojas lisas, bolígrafo a juego de fibra de trigo, solapa y tarjetero.

32 x 23 x 1,5 cm 1

50

B(1), F(1)



**NEW.**



**7978 Ledo**

Bloc de notas A5 con tapa rígida de efecto bambú con función soporte. Marcapáginas y 80 hojas a una línea.

15 x 21 x 1,5 cm 1/20 40  
E(1)



CUADERNOS | A5 | FUNCIÓN DE APOYO

**NEW.**



255 58 02



**7977 Darit**

Bloc de notas A5 con tapa rígida de RPET con función soporte. Banda elástica, marcapáginas y soporte para bolígrafo. 80 hojas.

15 x 21 x 1,5 cm 1/20 40  
E(1)





**NEW.**

# NEW SIKAS

BLOC DE NOTAS | A5 | SOPORTE PARA MOVIL Y BOLÍGRAFO

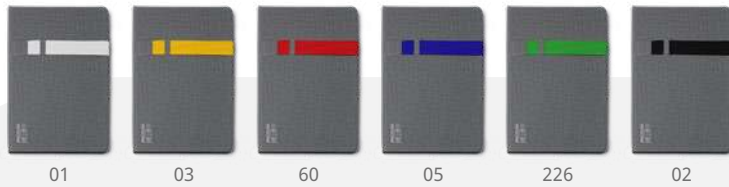

RECYCLED  
PET

### 7971 Sikas

Bloc de notas A5 con tapa rígida de RPET. Incluye soporte para bolígrafo y móvil. 80 hojas lisas.

14,6 x 21,4 x 1,5 cm

1/25

50

E(1), W, T

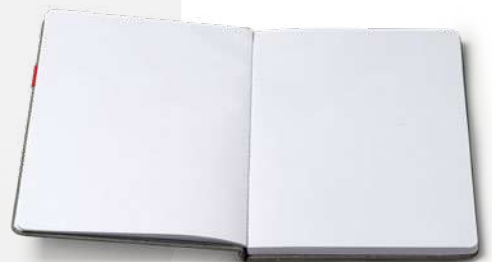





100%  
**RECYCLED**  
PET



RECYCLED  
PET

7979 **Soyer**

Bloc de notas A5 con tapa rígida de RPET.  
Marcapáginas y banda elástica a juego. 80 hojas.

14,7 x 21 x 1,5 cm 1/25 50

E(1)

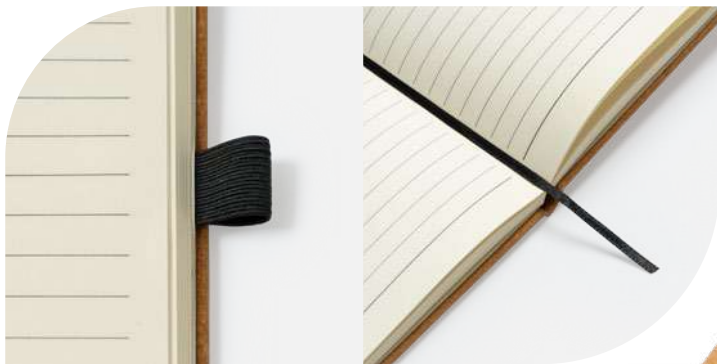

RECYCLED  
LEATHER

7974 **Korum**

Bloc de notas A5 con tapa rígida de cuero reciclado.  
Marcapáginas y banda elástica. 100 hojas a una línea.

14,5 x 21 x 1,4 cm 1/25 50

E(4), L2



100% **RECYCLED** LEATHER



# SET NOTEBROOK&PEN

WHEAT  
FIBERNATURAL  
CORK

COTTON

8081 **Robin** 

Bloc de notas A5 con tapas rígidas de corcho y algodón. 80 hojas lisas. Incluye soporte con bolígrafo de corcho y fibra de trigo a juego. Tinta negra.

 15,2 x 21 x 1,4 cm  1/25  50

 E(1), B(1), N(8), L2, W

## GALA



TAPAS DE BAMBÚ | PAPEL RECICLADO  
BOLIGRAFO DE BAMBÚ | PRESENTACIÓN CAJA DE CARTÓN



BAMBOO

8082 **Gala** 

Set libreta A5 y bolígrafo de bambú presentados en estuche de cartón Kraft. Libreta con tapas rígidas, 80 hojas de papel reciclado a una raya. Bolígrafo con detalles cromados y tinta azul.

 22 x 24 x 2,2 cm  1/20  40

 E(1), B(1)



**NEW.**



**7988 Andros**

Bloc de notas A5 con tapa rígida de corcho natural. Marcapáginas y banda elástica. 80 hojas.

14 x 21 x 1,5 cm 1/25 50  
E(4), L2



**8072 Cales**

Bloc de notas tamaño A6 con tapa rígida de corcho natural. Marcapáginas y banda elástica. 80 hojas lisas.

8,9 x 14 x 1,4 cm 1/50 100  
E(4), L2

# NATURALCORK

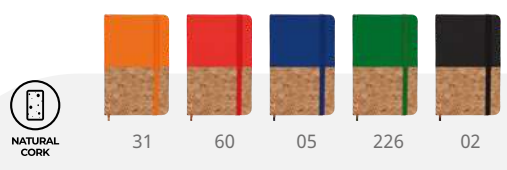

**8071 Iris**

Bloc de notas tamaño A6. Tapa rígida en corcho y polipiel. Marcapáginas y banda elástica. 80 hojas lisas.

9,3 x 14,3 x 1,5 cm 1/50 100  
E(4), L2



# PIANA



**NEW.**



## 7987 Piana

Bloc de notas A5 con tapa rígida de PU negro. Marcapáginas, banda elástica y soporte para bolígrafo a color. 80 hojas rayadas.

 14 x 21 x 1,5 cm  1/25  50  
 E(4), T

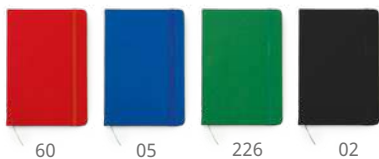

## 8091 Ardak

Bloc de notas A5 con tapa rígida de polipiel. Marca páginas y banda elástica. 100 hojas a una raya.

 14,7 x 1,5 x 21 cm  1/25  50  
 E(4), T, W







8051 **Coral**

8050 **Alba**

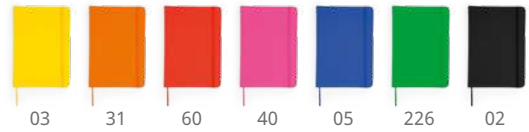

03 31 60 40 05 226 02

8050 **Alba**

Bloc de notas tamaño A5 con tapa rígida de polipiel. Marcapáginas y banda elástica. 100 hojas.

14,7 x 21 x 1,5 cm 1/25 50

E(4), T



31 60 40 05 55 226 02

8051 **Coral**

Bloc de notas tamaño A6 con tapa rígida de polipiel. Marcapáginas y banda elástica. 100 hojas.

9,3 x 14,3 x 1,5 cm 1/50 100

E(4), T

**+ antibacterial**  
ISO 22196

8061 **Elion**

Bloc de notas tamaño A6. Cubiertas de PU con tecnología anti-bacteriana. Marcapáginas y banda elástica. 80 hojas. Norma ISO 22196.

9 x 14 x 1,4 cm 1/50 100

E(4)



8060 **Watson**

Bloc de notas tamaño A5. Cubiertas de PU con tecnología anti-bacteriana. Marcapáginas y banda elástica. 100 hojas. Norma ISO 22196.

14,9 x 21 x 1,4 cm 1/25 50

E(4)



8061 **Elion**

8060 **Watson**



01 03 31 60



05 226 40 02



### 7994 **Leynax**



Libreta con espiral, hojas de papel liso y soporte para bolígrafo. Tapas rígidas y bolígrafo de cartón reciclado a juego. 70 hojas

15 x 1,9 x 18,2 cm 1/25 50

E(1), B(4)



31 60 05 226 02



### 8073 **Alani**



Libreta con espiral y tapa rígida de cartón reciclado. Bolígrafo a juego con tinta azul incluido. 60 hojas lisas.

16,5 x 21 x 1 cm 1/20 80

E(4)



01 03 60 05 226 02



### 8070 **Estela**

Bloc de notas tamaño A5 con tapa rígida de cartón reciclado. Marcapáginas y banda elástica a color. 100 hojas lisas.

14,7 x 21 x 1,5 cm 1/25 50

E(4)



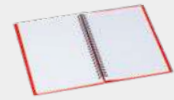
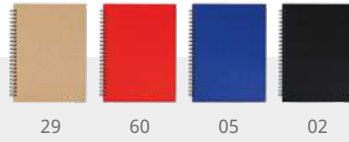
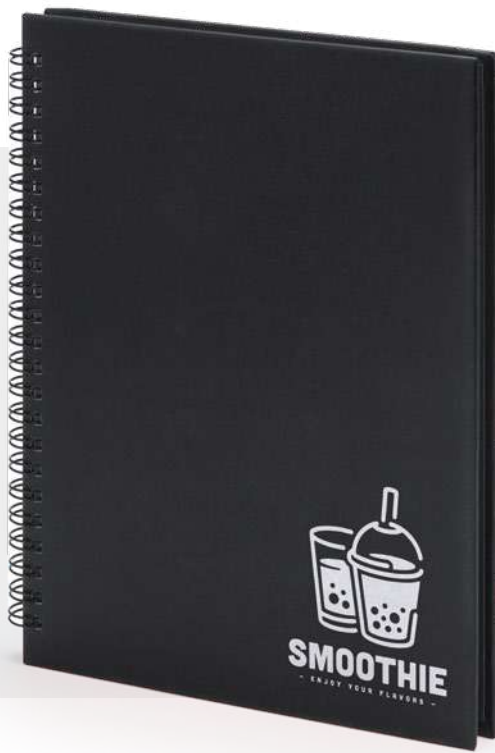

8052 **Valle**

Libreta con espiral y hojas de papel a rayas microperforadas. Tapa rígida de cartón reciclado. 80 hojas.

16,4 x 21,7 x 1,6 cm

1/25

50

E(4)

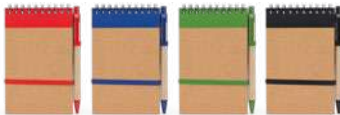

60

05

226

02



8074 **Lien** 

Libreta con espiral y tapa rígida de cartón reciclado. Bolígrafo a juego con tinta azul incluido. 70 hojas.

9,7 x 14,4 x 1 cm 1/50 100

D(4), B(4)



01

31

60

05

02

8054 **Arco** 

Mini libreta con espiral y tapa rígida de PP. 60 hojas de papel a rayas. Bolígrafo de tinta azul incluido.

7 x 9,5 x 0,7 cm 1/50 300

D(4), B(4)





**NEW.**  
COLORS

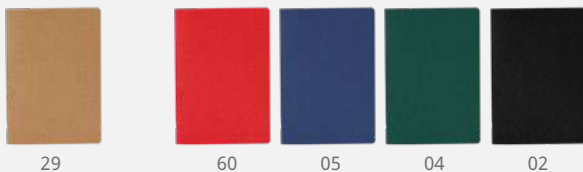

RECYCLED PAPER

8053 **Danica**

Libreta A5 de cartón reciclado. 60 hojas rayadas.

14,5 x 21 x 0,8 cm 1/10 100

E(1)



RECYCLED PAPER

8055 **Saler**

Libreta tamaño A6 de cartón reciclado. 60 hojas.

10,5 x 14,5 x 0,8 cm 1/20 200

E(1)



# CUBIERTAS DE PAPEL PLANTABLE

RECICLABLE | DEGRADABLE | CULTIVABLE



RECYCLED PAPER

## 8086 Sagra

Libreta A6 con cubiertas de papel reciclado y degradable con semillas. 40 hojas papel a una raya. Presentación en funda de papel kraft.

10,7 x 15 x 0,7 cm 1/100 200

E(1)



RECYCLED PAPER

## 8085 Garo

Bloc de notas con cubiertas de papel reciclado y degradable con semillas. Incluye 50 hojas de papel reciclado.

7,2 x 10 x 0,8 cm 100 200

C(1)



RECYCLED PAPER

## 8063 Bosco

Bloc de notas de diseño clásico con tapas de cartón reciclado. 200 hojas blancas. 125 notas adhesivas de distintos colores incluidas.

8,1 x 2,6 x 8,3 cm 1/50 100

D(2), W



### 8056 Innis

Original portanotas de cartón reciclado con 100 notas adhesivas en 5 colores variados.

5,4 x 8,2 cm 1/100 500

C(4)



01



29

### 8062 Dimas

Set de escritorio de cartón en forma de cubo compuesto por lapicero, bloc de notas (250 hojas) y 180 notas adhesivas en varios colores.

9 x 9 x 9 cm 1 40

D(2), W



### 8057 Anfi

Portanotas de anillas con original diseño en forma de bocadillo. Tapas rígidas de cartón reciclado. Incluye notas adhesivas en colores variados de dos tamaños: 100 grandes y 125 pequeñas.

8,3 x 10,7 x 2,3 cm 1/50 100

D(4)





NATURAL CORK



7546 **Vespula**

Estuche de corcho natural con forro interior de poliéster y cremallera.

23 x 11 x 2 cm 1/50 200

E(1), L2

**NATURALCORK**

**ESTUCHES**



01



03



31



60



05



226



02

7559 **Colina**

Estuche de acabado en colores lisos con cremallera a juego. Realizado en poliéster 600D.

22 x 11 cm 1/20 400

E(1), N(8), O

# CALENDARIOS 2024



## 8066 Flint

Calendario de sobremesa horizontal con anillas. Diseño mes en curso / mes anterior / mes siguiente / Calendario anual. Incluye santoral. Cuerpo de cartón ideal para marcar.

15,8 x 21 x 2,4 cm 1 20  
E(4)



## 8067 Glen

Calendario imantado con hojas removibles. Diseño mes en curso. Gran superficie de marcaje.

10 x 19 cm 25 400  
C(1)



## 8065 Dean

Calendario de sobremesa vertical con anillas. Diseño mes en curso / mes anterior / mes siguiente / Calendario anual. Incluye santoral. Cuerpo de cartón ideal para marcar.

10,8 x 13,8 x 6 cm 50 400  
E(4)



01 60 05 226 02

## 8068 Hera

Agenda con anillas tamaño A5. Tapas de PU acolchadas con grabado bajo relieve. 352 páginas. Diseño página día con esquinas troqueladas.

15,8 x 21 x 2,4 cm 1 20  
E(1), T, U

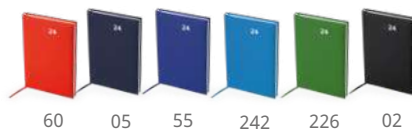

60 05 55 242 226 02

## 8059 Horus

Agenda tamaño A5 con cubierta de PU acolchada grabada en bajo relieve. 320 páginas más 4 páginas con mapas. Marcapáginas a juego con la cubierta.

15 x 21 cm 1 20  
E(1), T, U



450 55 02

## 8083 Selkis

Agenda con cubierta de polipiel acolchada grabada en bajo relieve. 320 páginas en color beige más 4 páginas con mapas. Marcapáginas a juego con la cubierta. Presentación en caja blanca.

17,6 x 24,5 x 2,1 cm 1 20  
E(1), T, U



### 8020 Fenix

Calendario de mesa perpetuo realizado en PP con espacio ideal para marcaje en tampografía.

14 x 4 cm

1/50

300

D(2)



BAMBOO

### 1002 Medus

Calendario perpetuo de sobremesa realizado en bambú, formado por soporte y cuatro bloques grabados. Presentación en caja eco.

13,6 x 4,6 x 5 cm

1/20

100

D(1), L2



01



60



05



226

### 3017 Serbal

Alfombrilla para ratón con calendario 2024. Cubierta de PVC traslúcida, hojas extraíbles con espacios para notas. Base antideslizante.

23 x 18 x 0,4 cm

1/50

100

E(4)



# BAGS & TRAVEL

# NEW VOLANO



05

47

02



TAMAÑO DE CABINA

## 7186 Volano **NEW.**

Trolley rígido en resistente ABS. Interior con dos compartimentos principales y bolsillo de rejilla auxiliar. Incluye cierre de seguridad integrado.

34 x 51 x 20 cm  1  2

 K(1), L2



TAMAÑO CABINA



# BLEIK



55



47



02

## 7187 **Bleik**

Trolley rígido en resistente ABS. Interior con dos compartimentos principales y bolsillo de rejilla auxiliar. Incluye cierre de seguridad TSA integrado.

 35 x 55 x 23 cm  1  1

 K(1), L2





**NEW.**





02



05



## 7178 **Garnes**

Trolley convertible en mochila. Realizado en poliéster 300D vigoré. Bolsillo principal de gran capacidad con compartimento interior acolchado ideal para portátil de hasta 17". Dos bolsillos con compartimentos interiores y bolsillo frontal. Estructura de alta calidad y resistencia. Tiras acolchadas ajustables. Fundas cubre ruedas antimanchas.

33,5 x 51 x 21 cm 1 4

1(8)



GARNES





# NEW WARKA

NEW.



## 7083 Warka

Mochila ejecutiva de viaje realizada en poliéster 300D. Dos bolsillos principales acolchados con compartimentos interiores y bolsillos ideales para portátil y Tablet. Espalda y cintas acolchadas. Bolsillo para ocultar las cintas y cinta para ajuste en trolley.

32 x 41 x 14 cm  1

 10

 G(1), N(8), O, P





7500 **Kalmar**

Portadocumentos acolchado para portátil realizado en poliéster reciclado RPET 600D con diseño vigoré. Dos compartimentos con cremallera impermeable. Asas de transporte y cinta bandolera ajustable a juego. Incluye cinta para trolley.

37 x 5 x 28 cm

1

30

F(1), N(8)



RECYCLED PET

05

58

02

7139 **Gregor**

Mochila de poliéster reciclado RPET 600D con diseño vigoré. Bolsillo principal acolchado ideal para portátil o tablet. Salida USB para conectar un power bank (no incluido). Bolsillo frontal y lateral. Tiras y espalda acolchadas.

29 x 43 x 13 cm

1

20

F(1), N(8), O, P



RECYCLED PET



7566 **Kebal**

58

05

Funda acolchada para portátil de hasta 15" realizada en poliéster reciclado RPET 300D.

39,5 x 29 x 3,5 cm

1

30

F(1), N(8)



# RECYCLED PET



58

255



## 7106 **Malmo**

Mochila realizada en poliéster reciclado RPET 600D con diseño vigoré. Cuerpo y bolsillo interior acolchados ideal para portátil. Doble compartimento con cremallera impermeable y bolsillo exterior. Asas acolchadas y cinta para trolley.

31 x 42 x 12 cm 1 20

G(1), N(8)



## 7176 **Sidney**

Mochila realizada en poliéster reciclado RPET 600D con diseño vigoré. Cuerpo y bolsillos interiores acolchados ideal para portátil y tablet. Doble compartimento y bolsillos laterales. Asas acolchadas.

31 x 45 x 13 cm 1 20

G(1), N(8)







02

58



NARVIK



7177 **Narvik**

Mochila realizada en poliéster 300D. Acabado OXFORD de diseño innovador. Bolsillo principal acolchado ideal para portátil y dos bolsillos frontales con elegantes tiradores. Incluye salida USB para conectar un power bank (no incluido) Tiras y espalda acolchada.

31 x 43 x 16 cm 1 20

N(8), G(1)

ORMOK

DEXTER

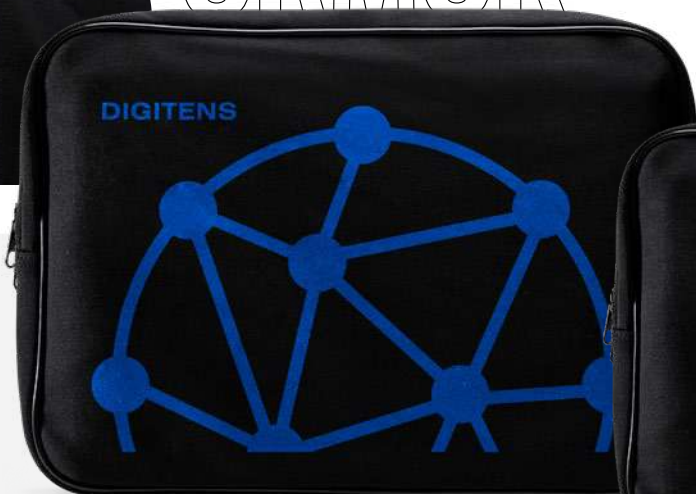

7568 **Ormok**

Funda para portátil de hasta 15" fabricada en softshell..

39 x 26,5 x 3,5 cm 1 25

F(1), N(8)



7567 **Dexter**

Funda para portátil de hasta 13" fabricada en softshell..

34 x 24 x 3 cm 1 25

F(1), N(8)



# ANTI-ROBO



## 7172 Moana

Mochila antirrobo realizada en nylon. Compartimento con salida USB para conectar un power bank (no incluido). Incluye cable micro USB. Bolsillo multiusos en tira derecha. Bolsillo principal con dos compartimentos acolchados ideal para portátil y tablet. Tiras y espalda acolchadas.

30 x 44 x 16 cm



1



10

G(1), N(8)



55

02

### 7171 Duke

Mochila realizada en nylon. Bolsillo interior acolchado ideal para portátil. Tiras y espalda acolchadas. Compartimento con salida USB para conectar un power bank (no incluido). Incluye cable micro USB.

30 x 45 x 20 cm



1



10

G(1), N(8)





02

58

55



### 7173 Mardok

Mochila realizada en nylon 600D. Tiras y espalda acolchadas. Incluye compartimento interior acolchado ideal para portátil.

32,5 x 44 x 25 cm 1 10

G(1), N(8)



58

243

255



### 7146 Chucao

Mochila para portátil de poliéster en acabado jaspeado. Tirantes, espalda y asas acolchadas. Doble compartimento frontal y bolsillos laterales. Etiqueta removible.

28 x 43 x 13 cm 1 15

Consultar







7515 **Lora**

Portadocumentos acolchado para portátil en suave poliéster 600D con bolsillo exterior. Asas de transporte a juego y cinta bandolera ajustable con mosquetón.

40,5 x 30 x 5,5 cm 1 50

F(1), N(8)



..... POLIESTER 900D



231

60

55

15

7138 **Dodo**

Mochila multifunción. Gran compartimento principal de apertura extensible con cremallera y ajustadores. Bolsillos laterales. Espalda y asas acolchadas.

44 x 30 x 10 cm 1 10

Consultar

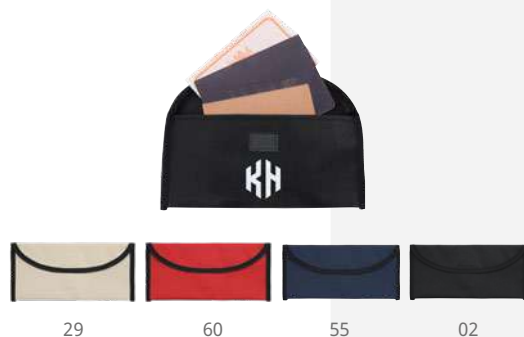

### 7518 Garza

Portadocumentos de viaje con cierre de velcro y práctica trabilla para el cinturón. Poliéster 600D.

27 x 13 cm

1/40

400

E(1), N(8)



### 7517 Charran

Portadocumentos de poliéster 600D en variados colores con asa de transporte y cremallera a juego.

40 x 29,5 x 5,5 cm 1/20 100

F(1), N(8)



### 7516 Libe

Portadocumentos de poliéster 600D con un compartimento principal y cierre de cremallera. Ribetes con refuerzo y asa de transporte integrada en el diseño.

38 x 32 cm

1/20

100

F(1), N(8)





**NEW.**

2991 **Covas**

Alarma personal. Se activa al separar el conector enganchado con el llavero. Presentación en caja diseño.

3,9 x 6,1 x 1,9 cm 1/50 300  
 D(4)



# DISFRUTA TU VIAJE



3014 **Gordon**

Adaptador de viaje universal. Válido para su uso en Europa, Asia, Estados Unidos y Australia. Presentación en caja blanca.

8,2 x Ø4,50 cm 1/50 100  
 D(4)



INDICADOR LED

3013 **Bopp**

Adaptador de viaje universal de diseño compacto y retráctil, con acabado mate y tacto suave. Válido para su uso en europa, asia, reino unido, estados unidos y australia. 2 puertos USB. Velocidad de carga 2100 mAh. Presentación en caja blanca.

6,1 x 5,6 x 4,5 cm 1/50 100  
 D(1), W





55

258

02

### 8201 Ansar

Almohadilla inflable de viaje con suave tacto antelina.

33 x 9 x 25 cm 1/20 200

F(1)



### 8200 Branta

Máscara de viaje realizada en suave microfibra. Doble elástico de ajuste.

18,5 x 9 cm 1/100 1000

D(1), N(8)



## HORA DE RELAJARSE



03

60

40

05

226

### 8199 Noys

Tapones para oídos de EVA. Presentación en estuche con cadena de transporte.

6,4 x Ø2,20 cm 1/200 1000

C(1)

NEW.



01



02

### 8151 Yllier

Zapatillas unisex realizadas en cómodo algodón/poliéster con interior acolchado. Práctica funda de non-woven incluida. Talla única 36-43.

11,5 x 29 x 1,7 cm 1/10 200

E(1), N(8)



NATURAL  
CORK



### 1126 Podox

Set de manicura con funda de corcho y cierre de corchete. Incluye tijeras, pinzas, cortaúñas, lima y quita cutículas de acero inoxidable.

11 x 6 x 2 cm 1/50 200

E(1), L1, N(8)

NEW.



NEW.

### 1125 Velvet

Set de manicura en bolsa de algodón con cierre de cordón ajustable. Incluye lima y cortaúñas.

12 x 7,8 cm 1/50 400

F(1), L1, N(8)



NEW.

### 8311 Chelsy

Set limpieza calzado de 5 piezas. Incluye calzador, paño, 2 cepillos y abrillantador en color neutro. Presentación en caja de metal.

14 x 4,7 x 10 cm 1 80

G(1), L2







## 8206 **Petra**

Identificador de maletas de corcho. Tarjeta identificadora incluida.

6 x 11,7 cm

50/100 500

D(1), L1



## 9935 **Arnold**

Necesar de viaje transparente realizado en PVC con cierre hermético. Incluye surtido de prácticos botes ideales para gel, champú y perfume.

19 x 19 cm

1

100

F(1)



**NEW.**



01



03



31



60

## 8204 **Charter**

Identificador de maletas con forma de trolley. Tarjeta identificadora incluida.

5,5 x 9,5 x 0,4 cm 1/50 500

C(4)





BOLSILLO TRASERO



7548 **Vultur**

Riñonera de poliéster 600D con dos compartimentos, uno frontal y otro trasero. Cremalleras y tiradores a juego. Cinta ajustable.

25 x 17 x 8 cm 1/20 100  
F(1), N(8)

# NEW CAMBRAI

NEW.



7573 **Cambrai**

Riñonera realizada en RPET 210D con compartimento principal y cierre de cremallera.

38 x 12 x 13 cm 25 200  
E(1), N(8), O





01 60 05 226 02



### 7544 Adal

Monedero con 2 bolsillos realizado en agradable polipiel RPET con cremalleras a juego. Anilla llavero incluida en el interior.

10,5 x 9 cm 1/10 500  
D(1), L1



01 03 31 60  
05 226 02 40

### 7542 Medea

Monedero realizado en agradable polipiel con cremallera a juego. Anilla llavero incluida en el interior.

10,5 x 7,5 cm 1/20 1000  
D(1), L1



NATURAL CORK

### 7545 Limosa

Monedero de corcho natural con forro interior y cremallera. Anilla de transporte incluida.

11 x 9 cm 1/100 800  
D(1), L2



NEW.



251 260 281

### 7570 Mauve

Monedero de PU en acabado brillante con cremallera y tirador a juego.

12 x 8,5 cm 1/10 1000  
D(1)

**NEW.**



7497 **Naro**

Neceser multiusos 100% algodón Fairtrade de 180 g/m<sup>2</sup>. Bolsillo principal con cremallera y tirador a juego.

21 x 13 x 8 cm

10

100

F(4), N(8), O, P

# FAIRTRADE COTTON

# CÁÑAMO NATURAL



261



152



02



HEMP

7499 **Prado**

Neceser multiusos realizado en tela de cáñamo 200 g/m<sup>2</sup>. Tirador a juego.

21 x 13 x 8 cm

1/10

100

F(1), N(8)

**NEW.**







# ALGODÓN RECICLADO



29 60 05 226 02



RECYCLED  
COTTON

## 7562 Remo

Neceser multiusos en algodón reciclado con cremallera y tirador a juego.

21 x 12 x 3 cm 1/50 300

F(1), N(8), O

# 100% ALGODÓN ORGÁNICO



60 05

226 29 02

## 7536 Delphis

Neceser 100% algodón orgánico de 180 g/m<sup>2</sup> con tirador a juego.

21 x 16 cm 1/50 300

F(1), N(8), O



## 7498 Zigari

Neceser multiusos 100% algodón Fairtrade de 180 g/m<sup>2</sup>. Bolsillo principal con cremallera y tirador a juego.

23 x 17 x 6 cm 50 300

F(4), N(8), O, P

# YUTE Y ALGODÓN



## 7563 Vera

Necesar realizado en algodón y yute laminado.  
Cremallera con tirador de yute a juego.

 20 x 15 x 6 cm  1/50  200

 F(1), N(8)

## 7564 Siena

Necesar realizado en algodón y yute laminado.  
Cremallera con tirador de yute a juego.

 21 x 11 x 6 cm  1/50  200

 F(1), N(8)

# 100% NATURAL



## 7560 Tyto

Necesar de yute natural con cremallera a juego.  
Tirador de yute.

 22 x 14 x 6,5 cm  10  200

 F(1)

7558 **Sierra**

Necesar multiusos realizado en algodón de 180 g/m<sup>2</sup> y yute. Cremallera con tirador de yute a juego.

21,5 x 16 x 5 cm 10 200

F(1), N(8)

# BOLSAS DE YUTE



2929



2960



2905



29226



2902

7537 **Doel**

Necesar multiusos en algodón de 280 g/m<sup>2</sup> con acabado bicolor. Cremallera con tirador de algodón a juego.

22,5 x 17 x 5,5 cm 1/50 300

F(1), N(8)







SUBLIMACIÓN



TACTO ALGODÓN

### 7569 Osak

Neceser ideal para sublimación. Realizada suave poliéster con forro interior. Cremallera con tirador a juego.

22 x 14 x 6,5 cm 1/25 500

F(1), N(8), R

# NECESÉRES



01 60 05 226 02



### 7547 Bubo

Neceser de dos compartimentos con cremalleras y cinta de transporte a juego. Realizado en poliéster reciclado RPET 210D.

21 x 13 x 8 cm 1/20 100

F(1), N(8), O





29 31 60 05 02 40

### 7565 Sedna

Neceser multiusos de poliéster 600D. Cierre de cremallera con tirador a juego.

22 x 14 x 6 cm 1/20 300

F(1), N(8), O



29 31 60 55 05 56 02

### 7513 Pardela

Neceser de poliéster 600D con cremallera y práctica asa de transporte.

20 x 10 x 8 cm 1/10 200

F(1), N(8), O



29 31 60 05 02 40

### 7514 Yubarta

Neceser de poliéster 600D. Cremallera con tirador a juego.

22 x 14 x 6 cm 10 300

F(1), N(8), O



01 03 31

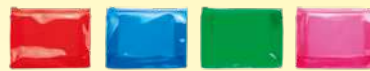

60 05 226 40

### 7511 Caribu

Neceser de PVC transparente con cierre hermético.

17 x 13 x 5 cm 1/50 400

F(1)



05



255



02



RECYCLED  
PET

7198 **Balmor** **NEW.**

Bolso multifunción realizado en RPET 300D de diseño vigoré. Capacidad 30L. Bolsillo principal y frontal con cierre de cremallera. Bolsillo lateral de rejilla. Incluye cinta bandolera ajustable.

50 x 28 x 24 cm 1 20

G(1), N(8), O, P



NEW BAL MOR



PROTEJE  
TU EQUIPAJE



60



55



02

7170 **Novak**

Bolso multifunción de poliéster 600D de gran capacidad. 5 compartimentos con cierre de cremallera. Base reforzada. Incluye cinta bandolera ajustable con almohadilla.

65 x 33 x 34 cm 1 20

G(1), N(8)



## MONDELO



NEW.

RECYCLED  
COTTON320  
g/m<sup>2</sup>7616 **MondeLO**

Bolso multifunción realizado en algodón reciclado de 320 g/m<sup>2</sup> en acabado jaspeado. Capacidad 24L. Bolsillo principal con cierre de cremallera. Incluye cómoda cinta bandolera ajustable.



60

05

226



29

02

49 x 24 x 26 cm



F(4), N(8), O, P



NEW.



29

60

05

226

02

RECYCLED  
COTTON320  
g/m<sup>2</sup>7179 **Firenza**

Mochila realizada en algodón reciclado de 320 g/m<sup>2</sup> en acabado jaspeado. Bolsillo frontal y asas acolchadas.

43 x 34 x 9 cm



F(4), N(8), O, P

## FIRENZA



60

05

55

02

### 7115 **Falco**

Mochila deportiva bicolor con bolsillo zapatillero acolchado. Bolsillo principal con doble tirador y bolsillo frontal exterior. 30 L de capacidad.

32 x 46 x 20 cm

1

10

Consultar



60

05

55

02

### 7120 **Columba**

Mochila deportiva con bolsillo zapatillero frontal. Compartimento frontal con doble tirador y bolsillo frontal exterior. 38 L de capacidad.

32 x 42 x 28 cm

1

10

Consultar





NEW.



### 7182 Oblak

Zapatillero realizado en poliéster 600D. Incluye práctica asa de transporte.

35 x 15 x 16 cm  1/25  100

 F(1), N(8), O

# DISFRUTA DE TU VIAJE



60



05

55

02

### 7121 Canary

Bolsa deportiva con doble asa y asa larga ajustable para colgar. Bolsillo principal con doble tirador. Bolsillo zapatillero con compartimento extraíble. Anti-humedad. Base con tacos. Fácil limpieza. 53 L de capacidad.

48 x 42 x 26 cm  1  10

 Consultar



# NEW OTAWA

**NEW.**



60



05



226



02

## 7183 Ottawa

Mochila deportiva realizada en Nylon 210D Ripstop de alta resistencia. Capacidad 30L. Doble compartimento principal con cierre de cremallera y bolsillos interiores. Compartimento de cuerda elástica frontal y bolsillos laterales de rejilla. Espalda y tiras acolchadas. Incluye cinta ajustable lateral.

32 x 47 x 20 cm



1



20

G(1), N(8)



### 7181 Misuri

Mochila deportiva realizada en poliéster 600D. Bolsillo principal y bolsillo frontal con cierre de cremallera. Compartimento de cuerda elástica frontal con bolsillos laterales de rejilla. Espalda y tiras acolchadas.

30 x 45 x 14 cm 1 40

F(1), N(8)



### 7153 Condor

Mochila de poliéster 600D con cierre de cremallera. Bolsillo frontal con salida para cables. Bolsillos laterales de diseño microperforado. Etiqueta removible.

30 x 40 x 18 cm 1 40

F(1), N(8), O



### 7154 Sison

Mochila ligera y compacta, en resistente poliéster 600D. Bolsillo frontal con apertura vertical y acolchado en espalda y tirantes. Etiqueta removible.

23 x 40 x 12 cm 1 50

F(1), N(8), O, R







03 31 60 55 05



12 226 15 78 02



256 248 246



135 243 252

DAVIDARCA

### 7124 Marabu

Mochila clásica con compartimentos de gran capacidad, realizada en poliéster 900D. Espalda y tirantes acolchados. Etiqueta removible.

30 x 40 x 18 cm 1 20

Consultar

### 7145 Teros

Mochila clásica de poliéster 300D con acabado jaspeado. Bolsillo frontal con salida para cables. Espalda y tirantes acolchados. Detalles en negro. Etiqueta removible.

30 x 40 x 12 cm 1 20

Consultar





### 7174 **Wilde**

Mochila realizada en poliéster 600D con dos compartimentos principales y bolsillo frontal. Bolsillo de redcilla lateral. Tiras y espalda acolchadas.

31 x 41 x 16 cm 1 40

F(1), N(8), O, P



### 7158 **Tucan**

Mochila clásica de resistente poliéster 600D, con compartimento principal y bolsillo frontal. Cierre de cremallera con tirador para fácil apertura. Espalda y tirantes acolchados. Etiqueta removible.

28 x 38 x 12 cm 1 50

F(1), N(8), O, P



226 60 05 02



7087 **Brest**

Mochila de cordones realizada 100% de algodón orgánico de 140 g/m<sup>2</sup>. Cordones en color natural.

37 x 41 cm 50 200  
F(4), N(8), P, O



NEW BARONE



7085 **Barone**

Mochila de cordones 100% algodón Fairtrade de 180 g/m<sup>2</sup>. Cordones a juego.

38 x 42 cm 50 150  
F(4), N(8), O, P



ORGANIC COTTON



7098 **Muna**

Mochila de cordones 100% de algodón orgánico.

38 x 42 cm 20 100  
F(6), N(8), O, P

NEW.



60

55

02

RECYCLED  
COTTON120  
g/m<sup>2</sup>7091 **Luanda**

Mochila de cordones en algodón reciclado con acabado jaspeado y algodón natural de 120 g/m<sup>2</sup>. Cordones en color natural.

38 x 42 cm

20

100

F(1), N(8), O, P

NEW LUANDA

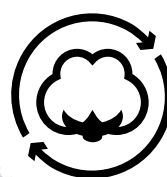
ALGODÓN  
RECICLADO

29

60

05

226

02

RECYCLED  
COTTON120  
g/m<sup>2</sup>7165 **Brescia**

Mochila de cordones en algodón reciclado de 120 g/m<sup>2</sup> con acabado jaspeado y cordones en color natural.

38 x 42 cm

50

100

F(4), N(8), O, P



29

60

05

226

02

RECYCLED  
COTTON140  
g/m<sup>2</sup>7107 **Varese**

Bolsa mochila de cordones en algodón reciclado de 140 g/m<sup>2</sup> con acabado jaspeado con asas largas de 70 cm a juego y cordones en color natural.

38 x 42 cm

20

100

F(6), N(8), O, P



CÁÑAMO

NEW.



200 g/m<sup>2</sup>



261



152



02

7090 **Naska**

Mochila de cordones realizada en tela de cáñamo 200 g/m<sup>2</sup>. Cordones a juego.

38 x 42 cm



10



100

F(1), N(8)



01



31



60



05



226



02

105 g/m<sup>2</sup>

7175 **Adare**

Mochila 100% de algodón con cordones a juego.

37 x 41 cm



10



100

F(6), N(8), M, O, P



120 g/m<sup>2</sup>

7557 **Wilkes**

Mochila de cordones realizada en algodón de 120 g/m<sup>2</sup> y yute.

34 x 43 cm



10



100

F(6), N(8), O, P



140 g/m<sup>2</sup>

7137 **Mirlo**

Mochila de cordones en 100% algodón de 140 g/m<sup>2</sup>. Cordones de 8 mm. Etiqueta removible.

34 x 42 cm



10



200

F(6), N(8), O, P

NEW.

7084 **Bremen**

Mochila de cordones con acabado multicolor realizada en poliéster 210D.

36 x 42 cm

50

200

F(1), N(8)

TACTO ALGODÓN

7180 **Kanda**

Mochila de cordones ideal para sublimación. Realizada en suave y resistente poliéster.

34 x 42 cm

10

100

F(1), N(8), R

# NEW LABUR

## MOCHILA DE ALTA VISIBILIDAD



NEW.



221



223



60



05

7184 **Labur**

Mochila de cordones con banda reflectante, realizada en poliéster 210D.

34,5 x 41 cm

10

300

F(1), N(8)



7157 **Zorzal**

Mochila deportiva de diseño plano y fácil personalización. Cordones planos a tono. Bolsillo interior con cremallera. 100% poliéster 600D. 150 g/m<sup>2</sup>.

35,5 x 42,5 cm 10 200  
F(1), N(8), O, P



7150 **Cuanca**

Mochila de cordones con ojales metálicos, realizada en poliéster 210D. Bolsillo frontal de diseño microperforado con cierre de cremallera y salida para cables. Etiqueta removible.

34 x 43 cm 10 200  
F(1), N(8)



7152 **Ninfa**

Mochila de cordones con esquinas reforzadas realizada en poliéster 210D. Bolsillo frontal con cremallera y salida para cables. Etiqueta removible.

34,5 x 45 cm 10 200  
F(1), N(8), R





31



01 03 60 05



55 226 02 78

### 7155 **Kagu**

Mochila con cordones gruesos a juego realizada en poliéster 210T. Cordones de 8 mm. Etiqueta removible.

35 x 45 cm 10 200  
F(1), N(8), R



01 60 05 226 02



### 7550 **Larus**

Mochila de cordones realizada en suave poliéster reciclado 210D con esquinas reforzadas.

34 x 42 cm 50 300  
F(1), R



01 03 31 60 78



48 63 55 05 20 02

### 7114 **Hamelin**

Mochila de cordones con ojales metálicos, realizada en poliéster 210D. Etiqueta removible.

34 x 42 cm 50 300  
F(1), N(8), R



991



992



993

### 7526 Milano

Mochila de cordones en poliéster 190T, con diseños deportivos.

43,5 x 43 cm

50

300

F(1), N(8)



01

03

31

60



05

226

02

78

### 7151 Calao

Mochila de cordones con ojales metálicos realizada en non-woven de 80 g/m<sup>2</sup>. Etiqueta removible.

36 x 42 cm

10

300

F(1)



995



996



997



998

### 7528 Elanio

Mochila infantil de cordones plegable en poliéster 190T. Bolsillo para plegado con diseños de animales.

26,5 x 32,5 cm

10

500

F(1), G(1)



### 9131 Pachu

Delantal infantil de non-woven con diseño para colorear. 5 ceras en varios colores incluidas. Talla única ajustable.

43 x 43 cm 1/50 200

F(1)



### 7530 Turcaz

Mochila infantil de cordones realizada en non-woven, con diseño para colorear. Incluye 5 ceras en colores variados.

25 x 30 cm 1/50 200

G(1)



### 7529 Azor

Bolsa infantil de non-woven con diseño para colorear. Incluye 5 ceras en colores variados.

20,5 x 22 cm 1/50 100

F(1)



**NEW.**

### 7571 Solaz

Estuche infantil de non-woven con diseño para colorear. Incluye 5 ceras de colores variados.

22 x 11 cm 1/50 200

F(1)

NEW SOLAZ







**NEW.**



03      60      05      226      02

7197 **Lubin**

Bolsa nevera plegable de poliéster 190T. Interior isotérmico de aluminio con cierre de cremallera. Asas reforzadas. Fácil plegado con cremallera.

45 x 36 x 9 cm    1/20    100

G(1)



10      05      47

**NEW.**

7088 **Sakra**

Mochila nevera de poliéster 210D Ripstop. Bolsillo principal y frontal con interior isotérmico. Compartimento de cuerda elástica frontal y bolsillos laterales de rejilla. Capacidad 20L. Espalda y tiras acolchadas.

26 x 40 x 19 cm    1    10

G(1), N(8)





BISMAR  
.....  
o

o  
.....  
MARLOX



255

243

7608 **Bismar**

Nevera de poliéster reciclado RPET con diseño vigoré. Bolsillo frontal e interior isotérmico. Incluye cinta de transporte ajustable.

25 x 15,5 x 15,5 cm



F(1), N(8)



255

243

7609 **Marlox**

Nevera XL de poliéster reciclado RPET con diseño vigoré. Doble compartimento y bolsillo frontal. Interior isométrico. Incluye cinta de transporte ajustable.

30 x 25 x 20 cm



F(1), N(8)



**NEW.**



55

02

7089 **Lombok**

Mochila nevera realizada en RPET. Bolsillo principal con interior isotérmico y bolsillo en la solapa. Bolsillos laterales de rejilla. Capacidad 19L. Espalda y tiras acolchadas.

30 x 43 x 15 cm



G(1), N(8)







60



05



02

### 7605 Grulla

Nevera multiusos de poliéster 600D. Compartimentos interiores isotérmicos y prácticos bolsillos exteriores. Cinta bandolera acolchada ajustable con mosquetón.

25 x 24 x 15 cm 1 20

G(1), N(8)

# NEW BAYONA



60



05



226



02

NEW.

### 7086 Bayona

Nevera multiusos de poliéster 600D. Bolsillo principal isotérmico y práctico bolsillo frontal. Incluye cinta de transporte ajustable.

26 x 34 x 19 cm 1 20

G(1), N(8)







### 7604 **Graja**

Mochila nevera de cordones con interior isotérmico de aluminio. Exterior de poliéster 210D.

32 x 42 cm

1/10

200

G(1), N(8)

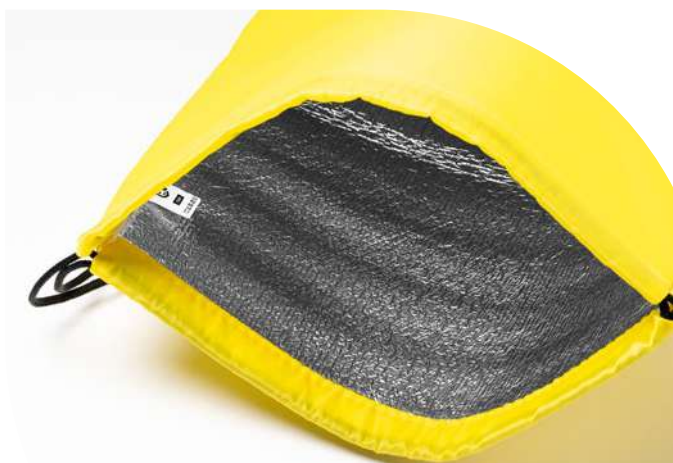

## TIBU



### 7603 **Tibu**

Nevera con interior isotérmico de aluminio para 6 latas. Exterior en resistente PVC. Asa de transporte a juego y cierre de cremallera.

21 x 15 x 15 cm

1/25

200

F(1), N(8)



### 7607 **Milana**

Nevera de papel laminado de diseño clásico, interior isotérmico de aluminio y solapa con cierre de cremallera. Práctica asa de transporte incluida.

19 x 13,5 x 14 cm 25 100

F(1)



03

60

05

226

### 7606 **Serreta**

Bolsa nevera de papel laminado, con interior isotérmico de aluminio. Solapa con cierre de velcro y práctica asa de transporte a color.

20 x 25 x 10 cm 10/50 100

F(1)



### 7600 **Kemer**

Bolsa Nevera de papel laminado con interior isotérmico de aluminio. Solapa y bolsillo exterior con cierre de velcro.

19 x 32 x 12 cm 25 100

F(1)

### 4130 Buren

Portabocadillos realizado en resistente papel laminado con cierre de cremallera. Interior isotérmico de aluminio. Incluye una práctica asa para transporte.

21 x 8 x 7,5 cm 1/25 200

F(1)



01 03 60 05 226 02

### 4131 Rigax

Portabocadillos realizado en PVC a color con cierre de cremallera. Interior isotérmico de aluminio. Incluye práctica asa para transporte.

21 x 8 x 7,5 cm 1/20 200

E(1), N(8)



01 60 05 226



RECYCLED PET

### 7599 Lombas

Porta Sandwich reutilizable realizado en poliéster reciclado RPET con interior isotérmico de PEVA. Cierre de velcro y fácil de limpiar.

18 x 18 cm 1/25 500

F(1)

NEW.





**NEW.**



01      60      05      226      02



7195 **Kimex**

Bolsa 100% algodón Fairtrade de 180 g/m<sup>2</sup> a color. Asas largas reforzadas de 70 cm.

38 x 42 cm

10

100

F(4), N(8), O, P

# FAIRTRADE BAGS

**NEW.**



7194 **Valmir**

Bolsa 100% algodón Fairtrade de 180 g/m<sup>2</sup> con asas largas reforzadas de 70 cm.

38 x 42 cm

50

150

F(4), N(8), O, P





NEW.



261

152

02

7191 **Serpa**

Bolsa realizada en tela de cáñamo 200 g/m<sup>2</sup>. Asas largas reforzadas de 70 cm.

38 x 42 cm

10

100

F(1), N(8)

# HEMP HEMP

NEW.



261

152

02

7190 **Mafil**

Bolsa realizada en tela de cáñamo 200 g/m<sup>2</sup> con fuelle. Asas largas reforzadas de 70 cm.

38 x 42 x 10 cm

10

100

F(1), N(8)





7167 **Greta**

Bolsa 100% algodón orgánico de 300 g/m<sup>2</sup> con prácticas asas largas de 70cm.

40 x 40 cm    10    100  
 F(4), N(8), O, P

# ORGANIC COTTON



7168 **Kensal**

Bolsa 100% algodón orgánico de 280 g/m<sup>2</sup> con fuelle y prácticas asas largas de 70cm.

38 x 42 x 9 cm    10    100  
 F(4), N(8), O, P



7159 **Narbona**

Bolsa 100% algodón orgánico de 120 g/m<sup>2</sup> con fuelle y asas cortas reforzadas de 35 cm.

40 x 40 x 10 cm    20    200  
 F(4), N(8), O, P



NEW.



163

261

262

264

ORGANIC  
COTTON7193 **Bondy**

Bolsa 100% algodón orgánico de 140 g/m<sup>2</sup> con asas reforzadas largas de 70 cm.

38 x 42 cm

50

200

F(4), N(8), P, O

# NATURAL BAGS

ORGANIC  
COTTON7156 **Berna**

Bolsa 100% algodón orgánico de 120 g/m<sup>2</sup> con asas largas reforzadas de 70 cm.

38 x 42 cm

50

200

F(4),N(8),O,P



29 60 05 226 02

### 7162 Rivoli

Bolsa 100% algodón reciclado de 120 g/m<sup>2</sup> en acabado jaspeado con asas largas de 70 cm.

38 x 42 cm 50 200

F(4), N(8), O, P



29 60 05 226 02

### 7617 Lumia

Bolsa realizada en algodón reciclado de 140 g/m<sup>2</sup> en acabado jaspeado con asas largas de 70 cm.

38 x 41 x 8,5 cm 1/50 200

F(4), N(8)



29 60 05 226 02

### 7107 Varese

Bolsa mochila de cordones en algodón reciclado de 140 g/m<sup>2</sup> con acabado jaspeado con asas largas de 70 cm a juego y cordones en color natural.

38 x 42 cm 20 100

F(6), N(8), O, P



60

05

02

**NEW.****7189 Inca**

Bolsa de algodón reciclado con acabado jaspeado y algodón natural de 120 g/m<sup>2</sup> con fuelle. Asas largas reforzadas de 70 cm.

 38 x 41 x 8 cm  20  100

 F(1), N(8), O, P

# RECYCLED COTTON

**NEW.**



60

05

02

**7188 Palmira**

Bolsa de algodón reciclado con acabado jaspeado y algodón natural de 120 g/m<sup>2</sup>. Asas largas reforzadas de 70 cm.

 38 x 42 cm  20  200

 F(1), N(8), O, P



# 100% ALGODÓN NATURAL

MISMO DISEÑO | DIFERENTE GRAMAJE

105  
g/m<sup>2</sup>

## 7520 **Hillock**

Bolsa de la compra cosida 100% algodón de 105 g/m<sup>2</sup>, con prácticas asas largas reforzadas de 70 cm.

 37 x 41 cm

 50

 250

 F(4), N(8), O, P

140  
g/m<sup>2</sup>

## 7601 **Hill**

Bolsa de la compra realizada en 100% algodón de 140 g/m<sup>2</sup>, con asas largas de 70 cm.

 37 x 41 cm

 20

 200

 F(4), N(8), O, P

180  
g/m<sup>2</sup>

## 7551 **Zenith**

Bolsa de la compra cosida en 100% algodón de 180 g/m<sup>2</sup>, con prácticas asas largas reforzadas de 70 cm.

 37 x 41 cm

 50

 150

 F(4), N(8), P

  
**PUPPYPAWS**  
YOUR ONLY ONE STOP PET STORE

100% NATURAL COTTON

**NEW.**



7521 **Knoll**

7160 **Niza**

7602 **Mountain**

7196 **Berlin**



03 60 05 226 02

7160 **Niza**

105 gr/m<sup>2</sup>

Bolsa 100% de algodón 105 g/m<sup>2</sup>. Asas largas de 70 cm a color.

37 x 41 cm 50 200  
F(4), N(8), O, P



**NEW.**

119

7196 **Berlin**

180 gr/m<sup>2</sup>

Bolsa 100% algodón de 180 g/m<sup>2</sup> con acabado multicolor. Asas largas reforzadas de 70 cm.

38 x 42 cm 50 150  
F(1), N(8), O, P



01 03 31 60



40 05 226 02

7521 **Knoll**

105 gr/m<sup>2</sup>

Bolsa de la compra cosida 100% algodón a color de 105 g/m<sup>2</sup>, con prácticas asas largas reforzadas de 70 cm.

37 x 41 cm 50 250  
F(4), N(8), O, P



01 03 31 60 40 05 226 02



48 63 55 242

**NEW.**  
COLORS

7602 **Mountain**

140 gr/m<sup>2</sup>

Bolsa de la compra en 100% algodón de 140 g/m<sup>2</sup> a color, con asas largas de 70 cm.

37 x 41 cm 20 200  
F(4), N(8), O, P



# 100% ALGODÓN



105 g/m<sup>2</sup>

## 7519 Baguette

Bolsa cosida 100% algodón de 105 g/m<sup>2</sup>, con clásico formato para el pan. Cierre de cordón grueso.

20 x 58 cm

10

500

F(1), N(8), O, P

105 g/m<sup>2</sup>

## 7525 Dune

Bolsa de la compra plegable 100% algodón de 105 g/m<sup>2</sup>, con asas largas de 70 cm y cordón para plegado ajustable.

37 x 41 cm

10

200

F(4), G(4), N(8), P



180 g/m<sup>2</sup>

## 7553 Leaf

Bolsa de la compra realizada en algodón de 180 g/m<sup>2</sup> con acabado liso y rejilla. Asas reforzadas de 60 cm.

45 x 42 cm

10

100

F(4), N(8)



120  
g/m<sup>2</sup>7615 **Zapax**

Bolsa realizada en algodón de 120 g/m<sup>2</sup>. Auto-cierre de cordones. Ideal para calzado.

42 x 34 cm

50

200

F(4), N(8)

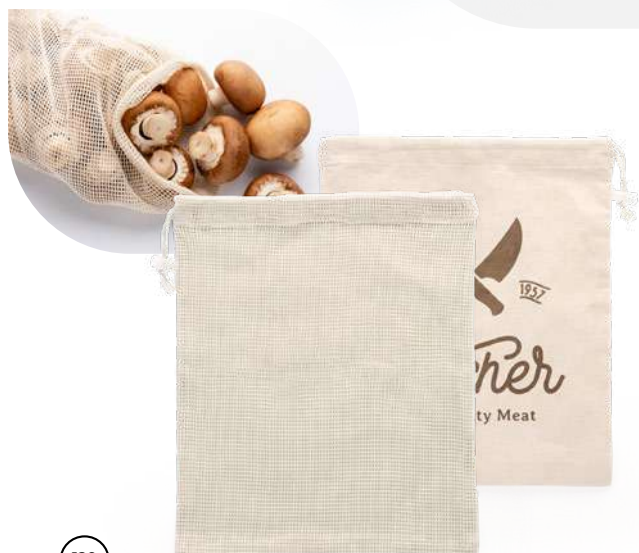
120  
g/m<sup>2</sup>7554 **Soil**

Bolsa de algodón de 120 g/m<sup>2</sup> con un lado en diseño liso y otro lado en diseño rejilla. Cierre de cordón ajustable.

25 x 30 cm

50

250

F(4), N(8)

105  
g/m<sup>2</sup>7552 **Ardea**

Bolsa estilo saco en algodón de 105 g/m<sup>2</sup> con auto-cierre de cordones.

15 x 21 cm

50

500

F(4), N(8), O, P

# NATURELOVERS

120  
g/m<sup>2</sup>7614 **Napa**

Bolsa realizada en algodón de 120 g/m<sup>2</sup>. Auto-cierre de cordones. Ideal para presentar botellas y termos.

12 x 33 cm

50

400

F(4), N(8)

**NEW.**

COTTON & JUTE

# NEW RAKU

NEW.

110  
g/m<sup>2</sup>



## 7185 Raku

Bolsa plegable 100% algodón de 110 g/m<sup>2</sup> con base de yute. Incluye bolsillo exterior. Asas reforzadas de 60 cm. Fácil plegado y cierre de cremallera.

35 x 39 x 10 cm 10 100

G(6), H(6), N(8)



JUTE & COTTON



29

60

226

05

## 7110 Nantes

Bolsa de yute laminado con dos caras de algodón ideal para marcaje y asas largas.

40 x 16 x 32 cm 10 50

F(4)

120  
g/m<sup>2</sup>7556 **Wave**

Bolsa de la compra realizada en algodón de 120 g/m<sup>2</sup> y yute, con prácticas asas reforzadas de 70 cm.

37 x 41 cm 10 200

F(6), N(8), O, P



o..... INTERIOR ISOTÉRMICO

7161 **Venice**

Bolsa nevera de yute laminado. Interior isotérmico de aluminio con cierre de velcro. Bolsillo frontal y asas en algodón natural.

43 x 20 x 34 cm 10 40

F(1), N(8)

7099 **Gavia**

Bolsa de yute laminado con bolsillo frontal y asas largas en algodón natural.

48 x 15 x 35 cm 10 80

F(1), N(8)







7149 **Nimes**

Bolsa de yute natural con asas reforzadas de algodón a color. Acabado cosido.

 38 x 41 cm

 10

 80

 F(1), N(8)

29

7148 **Koper**

Bolsa de yute natural laminado con ribetes y asas reforzadas de algodón. Acabado cosido.

 38 x 42 x 16 cm

 10

 50

 F(1), N(8)



7555 **Sterna**

Bolsa de yute natural con asas en algodón de 70 cm.

44,5 x 35 x 14 cm  5  60

 F(1)

100%  
JUTE

7164 **Flay**



Bolsa estilo saco de yute natural. Cierre con cordones de algodón.

25 x 32 cm  20  200

 F(1),N(8)

7163 **Parma**

Bolsa estilo saco de yute natural. Cierre con cordones de algodón.

14 x 22 cm  20  400

 F(1),N(8)





7610 **Grace**

Bolsa de yute laminado con ventana y doble compartimento. Ideal para botellas. Asas reforzadas.

20 x 34,5 x 10 cm 10 50

G(1), N(8)



7613 **Loire**

Bolsa de yute laminado y algodón. Doble compartimento y asas reforzadas. Ideal para dos botellas.

20 x 35 x 35 cm 10 60

F(4), N(8)





### 7612 **Belona**

Bolsa de yute laminado y algodón. Asas reforzadas.  
Ideal para botellas.

11 x 35 x 10 cm 20 80  
F(4), N(8)

CADA  
DETALLE  
IMPORTA



### 7611 **Nimba**

Bolsa de yute laminado con ventana. Asas reforzadas.  
Ideal para botellas.

10,5 x 35,5 x 10 cm 25 100  
G(1), N(8)

### 7122 Olmo

Bolsa de papel de 80 g/m<sup>2</sup> en acabado natural. Asas cortas reforzadas de diseño plano. Ideal para hostelería y restauración (take away).

30 x 29 x 20 cm  200

 F(1)



ASAS DE ALGODÓN



### 7123 Pinus

Bolsa de papel de 100 g/m<sup>2</sup> en acabado natural. Asas cortas reforzadas de diseño rizado. Ideal para botellas.

12 x 36 x 10 cm  100  400

 F(1)

### 7561 Milvus

Bolsa de resistente papel laminado de 130 g/m<sup>2</sup> con asas de algodón.

32 x 37,5 cm  1  250

 F(1)



29 01 60 55 02

### 7541 Maple

Bolsa de papel de 110 g/m<sup>2</sup>. Asas cortas reforzadas de diseño rizado.

41 x 32 x 12 cm 200

F(1)



29 01 60 55 02

### 7540 Roble

Bolsa de papel de 110 g/m<sup>2</sup>. Asas cortas reforzadas de diseño rizado.

32 x 40 x 12 cm 250

F(1)



29 01 60 55 56 02

### 7539 Haya

Bolsa de papel de 110 g/m<sup>2</sup>. Asas cortas reforzadas de diseño rizado.

22 x 23 x 9 cm 250

F(1)

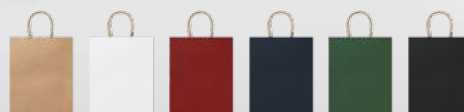

29 01 60 55 56 02

### 7538 Arce

Bolsa de papel de 110 g/m<sup>2</sup>. Asas cortas reforzadas de diseño rizado.

25 x 31 x 11 cm 250

F(1)







# RECYCLING SET

## 7147 Volga

Set de 3 bolsas de reciclaje realizadas en resistente pp-woven laminado mate con velcros laterales y asas reforzadas. Capacidad de cada bolsa: 40 litros.

99 x 44 x 28 cm  1  40  
 F(1)



01 31 60 05 226 02

## 7543 Coast

Bolsa reutilizable en acabado laminado brillante. Resistente PP woven de 120 g/m<sup>2</sup> con asas reforzadas de nylon y ribetes a juego en negro.

39 x 39 x 15 cm  20  100  
 F(1)





01 03 31 60



40 05 226 02



RECYCLED PET

### 7534 Phoca

Bolsa reutilizable cosida de acabado laminado mate. Fabricada en resistente non-woven RPET de 100 g/m<sup>2</sup> con asas reforzadas.

41 x 37 cm 10 250

F(1)



01 60 05 226



RECYCLED PET

### 7535 Orca

Bolsa reutilizable cosida de acabado laminado mate. Fabricada en resistente non-woven RPET de 100 g/m<sup>2</sup> con asas reforzadas y ribetes a juego.

42 x 35 x 15 cm 10 200

F(1)



01 60 05 226 02



RECYCLED PET

### 7549 Pantala

Bolsa de la compra plegable realizada en suave poliéster reciclado 210T. Práctico bolsillo para su plegado incluido.

33 x 46 x 8 cm 20 400

F(1), G(1), R



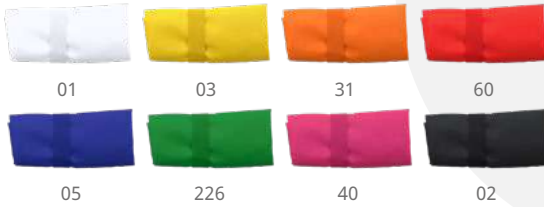

### 7522 Toco

Bolsa de la compra plegable de suave poliéster 190T en acabado cosido. Incluye práctica banda elástica para su plegado.

42,5 x 38 x 7 cm 1/20 400

F(1), G(1), H(1), R

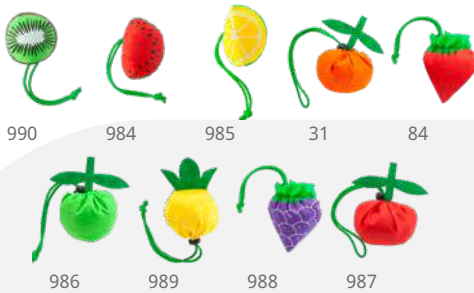

990 984 985 31 84  
986 989 988 987

### 7523 Focha

Bolsa de la compra plegable de suave poliéster 190T. Variados diseños de frutas con cordón ajustable de cierre.

40 x 38 cm 10 400

F(1), G(1)



SHOPPING BAGS



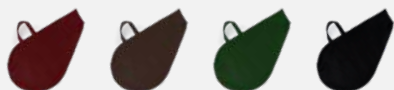

57

450

56

02

### 7128 Trevel

Funda para jamón de resistente non-woven con asas reforzadas y cierre de cremallera. Acabado cosido.

 68 x 41 cm

 1/50

 100

 F(1)

# NON WOVEN PRODUCTS



01

31

60

05

226

02

### 7166 Barnett

Bolsa de gran tamaño realizada en non-woven de 80 g/m<sup>2</sup>. Asas reforzadas de 58 cm y acabado cosido.

 33 x 38 x 25 cm

 10

 200

 F(1)



7125 **Boden**

Bolsa de non-woven de 80 g/m<sup>2</sup>. Asas cortas reforzadas de 35 cm y acabado termosellado.

 38 x 35 cm    
  50    
  250  
 F(1)

# COLORFULL BAGS



7503 **Lake**

Bolsa termosellada de non-woven de 100 g/m<sup>2</sup> con asas cortas.

 35 x 40 x 12 cm    
  50    
  250  
 F(1)



57 55 56 02

### 7502 River

Bolsa termosellada con diseño especial para botellas. Asa integrada en el cuerpo. Fabricada en non-woven de 80 g/m<sup>2</sup>.

17 x 40 x 10 cm 50 1000

F(1)



01 60 55 236 99 02

### 7501 Ocean

Bolsa termosellada de non-woven de 80 g/m<sup>2</sup> con asa integrada en el cuerpo.

40 x 30 x 10 cm 50 400

F(1)



01 60 78 99



236 226 02

### 7504 Sea

Bolsa termosellada de non-woven de 80 g/m<sup>2</sup> con asas largas y fuelle hexagonal.

54 x 40 x 10 cm 50 250

F(1)



# NON WOVEN SUBLIMATION BAGS



## 7506 Crest

Bolsa de non-woven de 80 g/m<sup>2</sup> con asas largas de 70 cm. Acabado termosellado.

36 x 40 cm 50 250  
F(1)

## 7527 Mito

Bolsa de la compra en non-woven cosido con asas reforzadas. Ideal para sublimación. Asas de 70 cm.

36 x 40 cm 50 250  
F(1), N(8), R

## 7126 Donet

Bolsa de non-woven de 80 g/m<sup>2</sup> con resistentes asas troqueladas y acabado termosellado.

34 x 43 cm 50 400  
F(1)

## 7127 Trento

Bolsa sublimable de non-woven de 80 g/m<sup>2</sup> con resistentes asas troqueladas y acabado termosellado. Ideal para sublimación.

34 x 43 cm 20 400  
F(1), N(8), R



TACTO ALGODÓN

**7618 Miso**

Bolsa ideal para sublimación. Realizada en suave y resistente poliéster. Asas largas de 70 cm.

42 x 38 cm

10

100

F(6), N(8), R

ESPECIAL PARA

# SUBLIMATION



TACTO ALGODÓN

**7569 Osak**

Neceser ideal para sublimación. Realizada suave poliéster con forro interior. Cremallera con tirador a juego.

22 x 14 x 6,5 cm

1/25

500

F(1), N(8), R



TACTO ALGODÓN

**7180 Kanda**

Mochila de cordones ideal para sublimación. Realizada en suave y resistente poliéster.

42 x 34 cm

10

100

F(1), N(8), R

# EATING & DRINKWARE





NEW.

NEW.

BOROSILICATE  
GLASS3986 **Adaya**

Jarra de cristal borosilicato efecto hielo especial sublimación. Capacidad 500 ml. Presentación en caja blanca.

BOROSILICATE  
GLASS4148 **Puket**

Vaso de cristal borosilicato efecto hielo especial sublimación. Capacidad 330 ml. Presentación en caja blanca.



# DISCOVER OUR NEW SUBLIMATION MUGS

3987 **Samui**

Jarra de cerámica con acabado brillante especial sublimación. Capacidad 700ml. Presentación en caja blanca.



NEW.

# PREMIUM QUALITY

3999 **Lemon**

350 ml

3999 **Lemon**

Taza de cerámica de alta calidad de 350 ml especial para sublimación. No incluye caja individual. Presentación en caja de 36 unidades.

9,6 x Ø8,20 cm 1 36

4003 **Rambu**

ACABADO MATE

4000 **Lima**4084 **Marang**

# SUBLIMATION MUGS

350 ml

4003 **Rambu**

Taza de cerámica de 350 ml con diseño en acabado mate. Especial para sublimación. Presentación en caja blanca.

9,6 x Ø8,20 cm 1 36



350 ml

4000 **Lima**

Taza de cerámica de 350 ml especial para sublimación. Presentación en caja blanca.

9,6 x Ø8,20 cm 1 36



250 ml

4084 **Marang**

Taza de cerámica de 250 ml, especial para sublimación. Presentación en caja blanca.

8,4 x Ø7,40 cm 1 48



# MAGIC MUGS



350 ml

## 4085 Okra

Taza mágica de cerámica en acabado mate. 350 ml de capacidad. Vierte líquido caliente en ella y descubre el diseño escondido. Presentación en caja blanca.

9,6 x Ø8,20 cm 1 36

F(1), Q



340 ml

## 4060 Kaffir

Taza de cristal de 340 ml. Especial para sublimación. Presentación en caja eco.

9,5 x Ø8 cm 1 36

F(1), Q



350 ml

## 4001 Mango

Taza de cerámica de 350 ml especial para sublimación. Interior y asa en color. Presentación en caja blanca.

9,6 x Ø8,20 cm 1 36

Q



300 ml

## 4002 Kumbo

Taza de cerámica con diseño retro especial para sublimación. Capacidad 300 ml. Presentación en caja blanca.

8,5 x Ø8,70 cm 1 36

Q



0103

0131

0160

0105

01226

0102



0160

0105

0102





3996 **Walax**

Taza de cerámica ideal para marcaje láser con el interior en blanco. Capacidad 350 ml. Presentación en caja blanca.

9,6 x Ø8,20 cm 1 36

F(1), L2



ESPECIAL PARA GRABADO LÁSER

# WALAX & MACHA



3997 **Macha**

Taza de cerámica ideal para marcaje láser con interior a color. Capacidad 350 ml. Presentación en caja blanca.

9,6 x Ø8,20 cm 1 36

F(1), L2

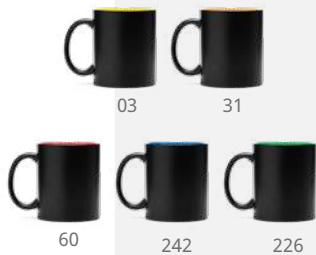

SPECIAL FOR LASER ENGRAVING  
**NEWROIBO**

**NEW.**

350 ml



226

03



60

05

02

**3992 Roibo**

Taza de cerámica ideal para marcate láser. Interior a color y exterior blanco. Capacidad 350 ml. Presentación en caja blanca.

9,6 x Ø8,20 cm 1 36

F(1), L2

350 ml



251

260

**4024 Zala**

Taza de cerámica de 350 ml con diseño en acabado brillo. Especial para grabado láser. Presentación en caja blanca.

9,6 x Ø8,20 cm 1 36

F(4), L2





300 ml

4010 **Jack**

Taza de cerámica de estilo retro con asa redonda. Capacidad 300 ml. Presentación en caja blanca.

8,6 x Ø8,50 cm 1 36  
F(4)



300 ml

4009 **Nolo**

Taza de cerámica con esmalte a color de 300 ml. Presentación en caja blanca.

10,4 x Ø8,50 cm 1 36  
F(4)



350 ml

4008 **Akebia**

Taza de cerámica de 350 ml. Interior y cuchara a color. Presentación en caja blanca.

10,5 x Ø8,30 cm 1 36  
F(4)







370 ml

4005 **Yuca**

Taza de cerámica de 370 ml. Presentación en caja blanca.

9,8 x Ø8,20 cm 1 36

F(4)



370 ml

4006 **Papaya**

Taza de cerámica en color de 370 ml. Presentación en caja blanca.

9,8 x Ø8,20 cm 1 36

F(4)

350 ml

4007 **Palta**

Taza pizarra de 350 ml. Incluye tiza. Presentación en caja blanca.

9,6 x Ø8,20 cm 1 36

F(1)





4057 **Sacha**

Vaso reutilizable con 380 ml de capacidad. Cuerpo en PP con recubrimiento de corcho natural. Presentación en caja diseño eco.

8,5 x Ø11 cm 1 40  
F(1), L1



ACABADO MATE



4013 **Rosella**

Taza de cerámica con diseño en acabado mate y base de corcho natural. Capacidad 420 ml. Presentación en caja eco.

11 x Ø9 cm 1 36  
F(1)



4012 **Berry**

Taza de cerámica en acabado mate con tapa de bambú natural. Capacidad 370 ml. Presentación en caja de cartón kraft.

10,5 x Ø8,20 cm 1 36  
F(1), L2



ACABADO MATE

## + antibacterial

ISO 22196



### 4064 Gosto

Vaso plegable anti-bacterias con tapa y mosquetón de transporte. 220 ml de capacidad.

9 x Ø3,70 cm 1/50 200

D(4), W



### 4062 Bustan

Vaso reutilizable de PLA con tapa enroscable y 450 ml de capacidad.

13,5 x Ø9,40 cm 1 50

F(1)



### 4063 Parcha

Taza reutilizable de PLA con 350 ml de capacidad.

8,8 x Ø7,90 cm 1/50 100

F(4)



### 4065 Yobo

Fiambrea realizada en PLA con cinta de ajuste en silicona. Tenedor, cuchara y cuchillo incluidos. Capacidad 1 L.

19,1 x 7,4 x 11,8 cm 1 40

E(1), W





# METAL MUGS

SUBLIMACIÓN



380 ml

## 4014 Damasco

Taza metálica de estilo retro especial para sublimación. Capacidad 380 ml. Presentación en caja blanca.

7,9 x Ø8,80 cm 1 48

L2, Q



0101

0301

6001

0501

5601

0201

380 ml

## 4015 Anon

Taza metálica de 380 ml con estilo retro. Presentación en caja blanca.

7,9 x Ø8,90 cm 1 48

F(4), L1



05

02

60

251

226

290 ml

## 4083 Kiwan

Taza metálica de doble pared con exterior a color. 290 ml de capacidad. Presentación en caja blanca

9 x Ø7,70 cm 1 50

F(1), L1

1,2 L

4069 **Brena**

Fiambra de acero inoxidable 304 con sistema de cierre de seguridad mediante hebillas laterales. Capacidad 1,2 L. Presentación en caja diseño eco.

19,6 x 7 x 13,6 cm  1  20

 F(1), L2



NEW.

450 ml

3985 **Teide**

Taza de acero inoxidable 304 con asas plegables. Capacidad 450 ml. Presentación en caja blanca.

8,2 x Ø9,20 cm  1  50

 F(1), L2



NEW TEIDE



03

60

05



226

02

230 ml

4082 **Guaya**

Taza metálica de doble pared con asa mosquetón. 230 ml de capacidad. Presentación en caja blanca.

8 x Ø7 cm  1  50

 F(1), L2





### 4066 **Korlan**

Fiambreira de acero inoxidable 304 con tapa de bambú y banda de seguridad en poliéster. Capacidad 800 ml. Presentación en caja diseño eco.

15,8 x 6,1 x 11,9 cm



F(1), L2



### 4103 **Daikon**

Fiambreira de acero inoxidable 304 con tapa de bambú. Sistema de cierre mediante hebillas laterales. Capacidad 1L. Presentación en caja diseño eco.

19,4 x 6,8 x 13,1 cm



E(1), L2



### 4117 **Colmer**

Set de cubiertos de bambú natural presentados en funda de algodón natural con cordón autocierre. Incluye tenedor, cuchillo y cuchara.

6,5 x 1 x 22 cm



F(1), B(4), L1, N(8)







### 4077 **Malow**

Set de 2 pajitas de acero inoxidable 304 con funda de algodón. Cepillo limpiador incluido.

25,5 x 6 cm

1/100

400

E(1), L1, N(8)



01

02

### 4068 **Ladas**

Pajita extensible reutilizable de acero inoxidable 304 con boquilla de silicona. Cepillo limpiador y estuche con mosquetón para transporte incluidos.

10,5 x Ø1,60 cm

1/100

500

E(1), L1



# SET DE CUBIERTOS

### 4030 **Belver**

Set de cubiertos de acero inoxidable presentados en una práctica funda de neopreno. Incluye tenedor, cuchillo y cuchara.

21 x 6 cm

1

100

F(1), L2

1L



### 4107 **Dalia**

Fiambrrera de cristal borosilicato con tapa hermética. Capacidad 1 L. Presentación en caja de diseño.

20,6 x 7 x 15,6 cm 1

20

F(1)



# GLASS LUNCH BOX



BAMBOO

900 ml

### 4061 **Sambal**

Fiambrrera de cristal borosilicato con tapa de bambú y banda de silicona. 900 ml de capacidad. Presentación en caja diseño eco.

20 x 6 x 15 cm 1

20

E(1), L2

# RPET COOLER BAGS



○  
●  
MARLOX

BISMAR  
○  
●



243

255

RECYCLED  
PET

## 7609 Marlox

Nevera XL de poliéster reciclado RPET con diseño vigoré. Doble compartimento y bolsillo frontal. Interior isométrico. Incluye cinta de transporte ajustable.

30 x 25 x 20 cm  1  25

 F(1), N(8)





243

255

RECYCLED  
PET

## 7608 Bismar

Nevera de poliéster reciclado RPET con diseño vigoré. Bolsillo frontal e interior isotérmico. Incluye cinta de transporte ajustable.

25 x 15,5 x 15,5 cm  1  60

 F(1), N(8)





### 4133 Vertus

Vaso de doble pared realizado en cristal borosilicato con tapa de bambú. Capacidad 350 ml. Presentación en caja diseño eco.

13,6 x Ø8,90 cm 1 40

F(1), L2

# GLASS & BAMBOO



### 3998 Indal

Taza de doble pared realizada en cristal borosilicato con tapa de bambú. Capacidad 280 ml. Presentación en caja diseño eco.

9,6 x Ø8,80 cm 1 40

F(1), L2



### 4081 Coco

Taza de cristal borosilicato con tapa y cuchara de bambú. 420 ml de capacidad. Presentación en caja diseño eco.

9,5 x Ø8 cm 1 36

F(1), C(4), L2

# FOR COFFEE LOVERS

BOROSILICATE  
GLASSDOUBLE  
WALL

90ml

## 4132 Capsul

Set de 2 vasos de doble pared realizados en cristal borosilicato. Capacidad 90 ml. Presentación en caja diseño eco.

6,6 x Ø6,70 cm 1/12 24

F(1)



NEW.

CRISTAL | BAMBÚ

# NEW BOTTLES

05

60

226



BOROSILICATE GLASS

4202 **Dalby**

Vaso de cristal borosilicato efecto hielo degradado a color. Tapa y pajita de bambú. Capacidad 350 ml. Presentación caja diseño eco.

14 x Ø7,50 cm 1 30

F(1), L2



BOROSILICATE GLASS

BAMBOO

NATURAL CORK

450 ml

4138 **Iroko**

Vaso realizado en cristal borosilicato con funda de corcho natural, tapa y pajita en bambú. Capacidad 450 ml. Presentación en caja diseño eco.

18 x Ø6,80 cm 1 30

F(1), G(1), N(8)

# GLASS CORK



# VACUUM FLASK



NEW.



## 4211 Coiba

Bidón térmico de acero inoxidable 304 doble pared con detalle en bambú. Tapa con asa función soporte. Capacidad 450 ml. Presentación en caja diseño eco.

22 x Ø7 cm

1

50

F(1), L2, W

NEW.



4206 **Cedro**

Termo doble pared de acero inoxidable 304 y bambú natural con infusor. Incluye termómetro digital táctil en la tapa. Capacidad 480 ml. Pila botón incluida. Presentación en caja diseño eco.

23,5 x Ø6,50 cm 1 30  
F(1), L2, W



# BAMBOO THERMOS



4032 **Kinata**

Termo de acero inoxidable 304 doble pared. Pared exterior en bambú natural. Capacidad 500 ml. Presentación en caja diseño eco.

24,5 x Ø6,90 cm 1 30  
F(1), L2, W



# BAMBOO & STAINLESS STEEL

4097 **Pana**4100 **Sotos**4035 **Fengi**4033 **Yaba**

BAMBOO



DOUBLE WALL



340 ml

## 4097 **Pana**

Taza de acero inoxidable con doble pared y exterior en bambú natural. Incluye tapa dosificadora. 340 ml de capacidad. Presentación en caja diseño eco.

10,8 x Ø8,20 cm 1

50

F(1), L2



BAMBOO



600 ml

## 4100 **Sotos**

Bidón de acero inoxidable 304 con tapón de bambú. Incluye cinta para transporte. 600 ml de capacidad. Presentación en caja diseño.

22 x Ø6,30 cm 1

50

F(1), L2, L3, W



BAMBOO



DOUBLE WALL



420 ml



## 4035 **Fengi**

Termo en acero inoxidable 304 de doble pared y bambú. Capacidad 420 ml. Incluye cinta de transporte. Presentación en caja diseño eco.

25,5 x Ø6 cm 1

25

F(1), L2



BAMBOO



DOUBLE WALL



500 ml

## 4033 **Yaba**

Vaso de acero inoxidable 304 con pared exterior de bambú natural. Capacidad 500 ml. Presentación en caja diseño eco.

17,5 x Ø8,20 cm 1

50

F(1), L2, W



NEW.



4203 **Saoko**

Bidón de cristal borosilicato de doble pared con tapa de bambú. Incluye infusor. Capacidad 420 ml. Presentación caja diseño eco.

23,9 x Ø7 cm

1

20

F(1), L2, W



FOR TEA  
LOVERS



4020 **Trilby**

Bidón de cristal de 450 ml con tapón de bambú y cintra de transporte en acabado natural. Presentación en caja diseño eco.

19,7 x Ø6,40 cm

1

50

F(1), L2, W



4136 **Lawas**

Bidón de cristal con funda de corcho natural. Tapón de bambú con práctica asa de transporte. Capacidad 500 ml. Presentación en caja diseño eco.

22,5 x Ø6,40 cm 1 30  
F(1), G(1), N(8)



# GLASS

# BOTTLES

4137 **Sibu**

Bidón de cristal con funda de yute simulado y tapón de bambú con práctica asa de transporte. Capacidad 500 ml. Presentación en caja diseño eco.

22,5 x Ø6,40 cm 1 30  
F(1), G(1), N(8)



01 60 05 226 02

4055 **Nagami**

Bidón de cristal con tapón de bambú y funda de silicona en color. Capacidad 540 ml. Presentación en caja diseño.

23,1 x Ø6,70 cm 1 30  
G(1), L2





500 ml

4040 **Camu**

Bidón de cristal de 500 ml. Funda y cinta de transporte a color. Presentación en caja diseño.

22 x Ø6,70 cm 1 40

F(1), G(1), N(8), L2, Q



600 ml

4098 **Kaster**

Bidón de cristal de 600 ml. Incluye funda a color con asa para transporte. Presentación en caja diseño.

16,2 x Ø8,80 cm 1 40

F(1), N(8), L2, R



CHOOSE YOUR FAVOURITE COLOUR





00

31

60



05

226

02

650ml

4099 **Sandi**

Bidón de cristal con cuerpo en color translúcido.  
Tapón de acero inoxidable. Capacidad 650 ml.  
Presentación en caja diseño.

26 x Ø7,10 cm

1

30

F(1), L2, W



## GLASS BOTTLES



00

03

31

60



40

05

226

02

500ml

4037 **Alfe**

Bidón de cristal con cuerpo a color. Capacidad 500 ml.  
Incluye cinta de transporte. Presentación en caja diseño.

22 x Ø6,30 cm

1

50

F(1), L2, W

# CHOOSE YOUR SIZE, CHOOSE YOUR FINISH.

MATT & SHINY

4093 Yisel

4149 Kemy



# MISMO DISEÑO



DOUBLE WALL



500 ml



4149 **Kemy**

Bidón térmico de acero inoxidable 304 doble capa.  
Capacidad 500 ml. Presentación en caja diseño.

23,5 x Ø6,80 cm 1 30

F(1), L2, L3, W



DOUBLE WALL



750 ml



4093 **Yisel**

Bidón térmico de acero inoxidable 304 con doble capa  
y aislamiento de cobre al vacío. Capacidad 750 ml.  
Presentación en caja diseño.

28,5 x Ø7,30 cm 1 20

F(1), L2

# DISTINTO TAMAÑO





4122 **Balax**

Bidón térmico de acero inoxidable 304. Doble pared con aislamiento de cobre. Capacidad 550 ml. Presentación en caja diseño.

22,5 x Ø7,40 cm 1 30

F(1), L2, L3, Q



**NEW.**  
COLOR

SUBLIMACIÓN



01



60



05



02



251



281



260

BALAX



SUBLIMACIÓN



01

03

60



05

226

02

800ml

4144 **Magun**

Bidón de acero inoxidable 304 en acabado sólido.  
Capacidad 800 ml. Presentación en caja diseño.

22,5 x Ø7,40 cm  1  40

 F(1), L2, L3, Q

W  
O  
I  
A  
M  
L  
B  
U  
S



DOUBLE WALL



500ml



4126 **Fancy**

Bidón térmico de acero inoxidable 304. Doble pared con aislamiento de cobre. Capacidad 500 ml. Presentación en caja diseño.

26,3 x Ø7 cm

1

30

F(1), L2, L3, W

SUBLIMACIÓN



01

60

05



260

251

02







SUBLIMACIÓN

4139 **Torke**

Bidón termo de acero inoxidable 304 doble pared.  
Capacidad 600 ml. Presentación en caja diseño.

26 x Ø6,90 cm 1 30

F(1), L2, L3

4059 **Copo**

Bidón termo de acero inoxidable 304 con doble  
pared especial para sublimación. Capacidad 500 ml.  
Presentación en caja diseño.

25,5 x Ø7,30 cm 1 24

L2, L3, Q

**NEW.**4145 **Beluga**

Bidón de acero inoxidable 304 con doble pared. Capacidad  
850 ml. Presentación en caja diseño.

30,5 x Ø8 cm 1 30

F(1), L2, L3, W



01

251

02



DOUBLE WALL



NATURAL CORK



460ml



### 4056 **Tayox**

Termo de acero 304 de doble pared con infusor de té y base de corcho. 460 ml de capacidad. Presentación en caja diseño.

24,5 x Ø6,40 cm



F(1), L2



# TAYOX

DOBLE PARED | 460ML.

## CORK & STAINLESS STEEL



01

251

02



DOUBLE WALL



NATURAL CORK



520ml



### 4105 **Kale**

Bidón térmico de acero inoxidable 304 doble pared y base de corcho. Capacidad 520 ml. Presentación en caja diseño.

27 x Ø7,10 cm



F(1), L2

SUBLIMACIÓN

DOBLE PARED | 500ML.

NEW TISSET



01

60

05

242

226

251

02



DOUBLE WALL



500ml

NEW.



### 4201 Tiset

Bidón de acero inoxidable 304 doble pared con tapa de bambú. Capacidad 500 ml. Presentación en caja diseño

21 x Ø7,30 cm



30

F(1), L2, L3, W, Q



SUBLIMACIÓN



01

60

05

251



BAMBOO



620ml

### 4039 Boina

Bidón de acero inoxidable 304 y bambú. Capacidad 620 ml. Presentación en caja diseño.

21 x Ø7,30 cm



50

F(1), L2, Q





SUBLIMACIÓN



01

60

05

251

02



DOUBLE WALL



500ml



### 4123 Salvia

Termo de acero inoxidable 304 con doble pared. Acabado brillo. Capacidad 500 ml. Presentación en caja diseño.

24,5 x Ø6,90 cm 1

30

F(1), L2, L3



SUBLIMACIÓN



01

251

02



DOUBLE WALL



450ml

### 4106 Palmer

Termo de acero inoxidable 304 doble pared. Botón de apertura con cierre de seguridad. Capacidad 450 ml. Presentación en caja de diseño.

22 x Ø6,50 cm 1

30

F(1), L2



DOUBLE WALL



450ml



60

05

251

### 4135 Dango

Termo multiusos ideal para comida de acero inoxidable 304 doble pared. Doble tapa con cuchara plegable de acero inoxidable incluida. Capacidad 450 ml. Presentación en caja diseño.

15,7 x Ø9,50 cm 1

20

F(1), L2, L3



06 55 56 02



DOUBLE WALL



450ml



ACERO INOXIDABLE | DOBLE PARED

# THERMO CUP



## 4134 Okele

Vaso térmico de acero inoxidable 304 de doble pared. Tapa con rosca antifugas y práctico tapón para beber. Capacidad 450 ml. Presentación en caja diseño.

14,6 x Ø8,90 cm 1 40

F(1), L2, L3

BASE ANTIDESLIZANTE



01 31 60 05 226 251 02



## 4029 Milu

Vaso de acero inoxidable de 290 ml con tapa en PP. Presentación en caja diseño.

14,4 x Ø7,30 cm 1 50

F(1), L2, L3, W



01 60 05 251 02



## 4028 Salak

Vaso de acero inoxidable de 310 ml con tapa en PP. Presentación en caja diseño.

16,7 x Ø7,20 cm 1 50

F(1), L2, W

# BIDONES ACERO INOXIDABLE

4125 Tarek



790ml

## 4125 Tarek

Bidón de acero inoxidable 304 de acabado mate. Capacidad 790 ml. Presentación en caja diseño.

25,7 x 07,40 cm 1 50

F(1), L2, L3, W

4042 Alpina



700ml

## 4042 Alpina

Bidón de acero inoxidable 304. Capacidad 700 ml. Presentación en caja diseño.

25,5 x 07,10 cm 1 50

F(1), L2, L3, W

NEW.

4200 Selby



700ml

## 4200 Selby

Bidón de acero inoxidable 304 especial para sublimación. Capacidad 700 ml. Presentación en caja diseño.

25,7 x 07,10 cm 1 40

L2, L3, Q

SUBIMACION





01

60

05

226

02



#### 4011 Pita

Bidón de acero inoxidable 304. Capacidad 630 ml. Diseño en color sólido de acabado mate. Presentación en caja diseño.

 25,5 x Ø7,10 cm  1

 30

 F(1), L2, L3, W



01

60

05

02



#### 4034 Alke

Bidón de acero 304 con cuerpo en 2 tonos y acabado mate. Tapón con asa flexible de goma. Capacidad 850 ml. Presentación en caja diseño.

 24,7 x Ø7,50 cm  1

 30

 F(1), L2, L3



60

05

226

251

02



**NEW.**

4212 **Lewik**

Bidón de aluminio reciclado con tapón y cinta de transporte a juego. Capacidad 600 ml. Presentación en caja diseño eco.

22,5 x Ø6,60 cm 1 50

F(1), L2, L3, W

**RECYCLED ALUMINUM**

# RECYCLED ALUMINIUM



01

60

05

226

251

02

**NEW.**

## 4214 Renko

Bidón de aluminio reciclado con mosquetón a juego.  
Capacidad 400 ml. Presentación en caja diseño eco.

17,5 x Ø6,60 cm  1  50

 F(1), L2, L3, W

**NEW.**

## 4213 Kisko

Bidón de aluminio reciclado. Capacidad 550 ml.  
Presentación en caja de diseño eco.

23,5 x Ø6,60 cm  1  50

 F(1), L2, L3, W



01

60

05

226

251

02



## NEWBOTTLES

NEW.

4205 Broly

NEW.

4204 Gelda





800ml

BAMBOO

4205 **Broly**

Bidón de aluminio con mosquetón y tapón de bambú.  
Capacidad 800 ml. Presentación en caja diseño eco.

24,3 x Ø7,30 cm  1  40

 F(1), L2, L3, W





400ml

BAMBOO

4204 **Gelda**

Bidón de aluminio con mosquetón y tapón de bambú.  
Capacidad 400 ml. Presentación en caja diseño eco.

17,1 x Ø6,60 cm  1  50

 F(1), L2, L3, W

SUBLIMACIÓN



800ml

4049 **Baobab**

01 60 05 226 02

Bidón de aluminio con mosquetón. Capacidad 800 ml.  
Presentación en caja diseño.

24,6 x Ø7,30 cm 1 50

F(1), L2, L3, W, Q



SUBLIMACIÓN



400ml

4045 **Athletic**

01 60 05 226 251 02

Bidón de aluminio con mosquetón. Capacidad 400 ml. Presentación en caja diseño.

17,5 x Ø6,60 cm 1 50

F(1), L2, Q

330ml

4004 **Yaca**

01 03 60 05 226 02

Bidón de aluminio con mosquetón de color a juego. Capacidad 330 ml. Presentación en caja diseño.

15 x Ø6,60 cm 1/50 100

F(1), L2, L3



01 03 60 05



226 251 02

680 ml

4058 **Chito**

Bidón de aluminio con cuerpo en acabado sólido. 680 ml de capacidad. Tapón con boquilla retráctil y asa de transporte. Presentación en caja diseño.

22,1 x Ø7,30 cm 1 50

F(1), L2



00 31 60 05 226 02



4067 **Valsan**

Bidón de RPET con cuerpo en color translúcido. Capacidad 600ml. Cinta de transporte incluida. Presentación en caja diseño eco.

21,5 x Ø6,50 cm 1 50

F(1), L2

100%  
**RPET**





00 60 05 226



#### 4041 Eddo

Bidón de 700 ml en acabado AS transparente. Tapón y base de acero inoxidable. Presentación en caja diseño.

26,5 x Ø7,10 cm 1 30

F(1), L2, W



01 03 60



05 226 02



#### 4038 Kinkan

Bidón de tritán con cuerpo en color translúcido. Tapón a juego con asa de transporte integrada. Capacidad 650 ml. Presentación en caja diseño.

25,7 x Ø6,70 cm 1 50

F(1), W

# CHOOSE YOUR BOTTLE



01 60 05 226 02



#### 4044 Aloe

Bidón de tritán de 600 ml. Tapón con cinta de transporte a color. Presentación en caja diseño.

22,5 x Ø6,60 cm 1 50

F(1), W



# SOFTFLASK



01 05

## 4104 Trail

Bidón plegable realizado en TPU flexible. Incluye asa de transporte. Ideal para eventos deportivos. Capacidad de 500 ml.

25 x 9 cm 1/50 400  
F(1)



01 05

## 4119 Track

Vaso plegable ideal para eventos deportivos realizado en TPU flexible. Capacidad 230 ml.

10,7 x Ø6,80 cm 1/50 600  
F(1)



01 03 60 05 226



## 4086 Mandy

Bidón de RPET flexible con forma de camiseta. Tapón de seguridad y mosquetón de transporte. 470 ml de capacidad.

17 x 25,5 x 3,3 cm 1/50 400  
E(1)



01 03 31 60 05 226 02



520ml

### 4046 Running

Bidón deportivo de PE. Capacidad 520 ml.

19,5 x Ø6,50 cm 1/10 100

F(1)



# SPORT BOTTLES



01 03 31 60 05 226 02



840ml

### 4036 Kumat

Bidón deportivo de PE con 840 ml de capacidad.

23,5 x Ø7,50 cm 1/10 50

F(1)



01 03 31 60 05 226 02



620ml

### 4047 Biking

Bidón deportivo de PE con amplia superficie para marcaje. Capacidad 620 ml.

20,5 x Ø7,50 cm 1/10 100

F(1)





**HOME, GIFTS  
& PREMIUM**



NEW.



NEW.



HEMP FABRIC

200 g/m<sup>2</sup>9139 **Bost**

Delantal largo de sarga en poliéster reciclado y algodón reciclado. Tirante con cierre ajustador. Cintas laterales para lazada. Dos bolsillos frontales.

70 x 90 cm

1

50

E(4), N(8)

200 g/m<sup>2</sup>9140 **Maule**

Delantal realizado en tela de cáñamo 200 g/m<sup>2</sup> con bolsillo frontal. Talla única ajustable.

65 x 90 cm

10

100

E(4), N(8)

**NEW.**



**9142 Nopal**

Paño de cocina 100% algodón de 180 g/m<sup>2</sup>.

40 x 65 cm    10    200  
 F(1), N(8), O, P



**NEW.**



**9143 Peyot**

Mantel individual 100% algodón Fairtrade de 140 g/m<sup>2</sup>.

45 x 30 cm    10    300  
 F(1), N(8), O, P



FAIRTRADE COTTON



**9141 Taber**

Delantal 100% algodón Fairtrade con bolsillo frontal.  
 Talla única ajustable.

65 x 90 cm    10    100  
 E(4), N(8), P





# RECYCLED COTTON



226



29



60



02



05

RECYCLED  
COTTON

## 9136 Arola

Delantal realizado en algodón reciclado con acabado jaspeado. Bolsillo frontal. Talla única ajustable.

93 x 65 cm

10

100

F(4), N(8), P

ORGANIC  
COTTON

## 9135 Oliver

Delantal 100% algodón orgánico con bolsillo frontal. Talla única ajustable.

93 x 65 cm

10

100

F(4), N(8), P

PARTE LISA  
PARA MARCAJE

**NEW.**
RECYCLED  
COTTON

## 9144 Forset

Manopla 100% de algodón reciclado. Una cara lisa ideal para marcaje y cinta para colgar.

18,5 x 26 cm

1/50

200

E(1), N(8)

PARTE LISA  
PARA MARCAJE

ORGANIC  
COTTON

## 9138 Mauro

Manopla 100% de algodón orgánico. Una cara lisa ideal para marcaje y cinta para colgar.

30,5 x 19 cm

1/25

200

E(1), N(8)

# ORGANIC COTTON





9128 Ramsay



9129 Ducasse



01 60 05 02

### 9128 Ramsay

- Delantal largo de sarga:
- Cinta a tono en cuello.
  - Cintas laterales para lazada.
  - Medida: 90 x 65 cm

65 x 90 cm 50 100

Consultar



01 03 31 60 40 05 114 02

### 9129 Ducasse

- Delantal largo de popelín.
- Cinta a tono en cuello.
  - Cintas laterales para lazada.
  - Dos bolsillos frontales, uno interior y uno grande superpuesto.
  - Medida delantal: 90 x 65 cm
  - Medidas de bolsillo: 25 x 16 cm.

65 x 90 cm 10 100

Consultar



01 03 60 40



05 226 02



01 60 05

### 9133 Jamie

Set infantil de delantal y gorro, realizado en non-woven de 80 g/m<sup>2</sup>. Talla única ajustable. Medidas del bolsillo del delantal: 17 x 17 cm.

DELANTAL: 59,5 x 49 cm GORRO: 30 x 20 cm

10 300 F(1)

### 9130 Keller

Delantal de non-woven a color con bolsillo central. Talla única ajustable. Medidas del bolsillo: 22 x 17 cm.

50 x 73 cm 10 200

Consultar



### 9134 Roger

Manopla de cocina en poliéster. Acabado en color blanco con bordes y cinta para colgar en color. Cara lisa ideal para sublimación.

19 x 30,5 cm 1/50 200  
E(1), N(8), R



# SPECIAL FOR SUBLIMATION



PARTE LISA  
PARA MARCAJE



### 9137 Eneko

Set de cocina compuesto por agarrador y manopla en suave algodón/poliéster. Una cara lisa ideal para marcaje y cinta para colgar.

30,5 x 19 cm 1/10 100  
E(1), N(8)

# KITCHEN GLOVES



PARTE LISA PARA  
MARCAJE

### 9132 Roca

Manopla de cocina en suave algodón / poliéster con una cara lisa para marcaje.

19 x 30,5 cm 25 200  
E(1), N(8)





NEW.



BAMBOO



4147 **Baru**

Espátula de cocina de bambú natural.

6 x 30 cm

1/50

200

C(4), L1



NEW.

# NEW KITCHEN ACCESSORIES



BAMBOO



4146 **Nori**

Cuchara de cocina de bambú natural.

6 x 30 cm

1/50

200

C(4), L1



BAMBOO



5 KG



3028 **Rabil**

Báscula de cocina digital con carcasa frontal de bambú natural. Capacidad máxima de 5 kg. Funciona con una pila botón incluida. Presentación en caja diseño eco.

15 x 1,6 x 21,5 cm

1/10

20

E(1), L2, W



4116 **Angus**4114 **Devon**4115 **Boran**

BAMBOO

4114 **Devon**

Tabla de cortar de bambú natural.  
Troquelado para colgar y fácil manejo.  
Presentación en caja eco.

15,3 x 1 x 20 cm  1  50  
 E(1), L2



BAMBOO

4115 **Boran**

Tabla de cortar de bambú con mango  
para fácil manejo y cuerda para colgar.  
Presentación en caja eco.

40 x 1 x 13,5 cm  1  30  
 E(1), L2



BAMBOO

4116 **Angus**

Tabla de cortar de bambú natural con perfil  
recoge líquidos. Presentación en caja eco.

30 x 1,2 x 20 cm  1  20  
 E(1), L2

# CUTTING BOARDS





### 4102 **Comte**

Set de quesos con 4 utensilios de acero inoxidable y mango de madera. Presentados en práctico estuche de madera con tabla para cortar en la zona superior. Presentación en caja blanca.

3,6 x Ø20 cm



1



10

E(1), L2

MADERA & ACERO INOXIDABLE

# PARA AMANTES DEL QUESO



### 4101 **Edam**

Set para quesos con 4 utensilios de acero inoxidable y mango de madera. Presentados en un elegante estuche con interior acolchado.

21,5 x 3,4 x 17,4 cm



1/10



40

F(1), L1





### 4140 **Pinea**

Set de 4 posavazos realizados en madera de pino natural. Presentación con cuerda de yute natural y caja diseño eco.

10 x 4,5 cm

1/25

50

E(1), L2

# WOOD & CORK



### 4113 **Algor**

Set de 4 posavazos de bambú natural. Presentación en caja de diseño eco.

11,6 x 3,6 x 11,6 cm

1

20

E(1), L2



### 4087 **Chala**

Posavazos de corcho natural.

Ø10 cm

10/500 1000

D(1), L1, W

# NEW WINE COOLERS



NEW.



NEW.

CIERRE DE VELCRO



57

55

02

## 7082 Frost

Enfriador de botellas de poliéster. Con cintas elásticas para un ajuste perfecto.

15,5 x 22,5 cm 1/25 50

F(1)



## 7081 Moke

Enfriador de botellas realizado en RPET. Cierre ajustable de velcro.

40 x 18 cm 1/25 50

F(1)



### 4112 Malbec

Set de vino con accesorios de acero inoxidable, sacacorchos con cortacápsulas, recogegotas, tapón y dosificador. Presentado en caja de metal con interior acolchado y funda de diseño eco.

18 x 4 x 11 cm 1 20

G(1), L2



# WINE LOVERS



01

116

02

### 4075 Merlot

Sacacorchos de estilo clásico en acero inoxidable con dos posiciones. Presentación en caja blanca.

12 x 2,1 x 1,3 cm 1/10 200

D(1), L1



01

60

05

02



### 4118 Garnac

Sacacorchos de estilo clásico en acero inox. Con cortacápsulas y abridor. Presentación en caja blanca.

11 x 1,2 x 2,2 cm 1/10 200

D(1)



IMÁN

### 4076 Syrah

Sacacorchos metálico con forma de botella en plástico. Presentación en caja blanca.

12 x Ø2,50 cm 1/50 200

D(1)







NATURAL CORK



4091 **Venet**

Set de vino con accesorios en acero inoxidable, sacacorchos de 2 tiempos con cortacápsulas, recogebotas, dosificador y tapón. Presentado en estuche de corcho natural con interior acolchado y caja de diseño eco.

4,2 x Ø14,90 cm 1 20

F(1), L2



4 ACCESORIOS



# WINESET

CORK | WOOD



BAMBOO

4129 **Tintos**

Set de vino con accesorios de acero inoxidable y detalles en bambú, sacacorchos con cortacápsulas, tapón y recogebotas. Presentado en estuche de bambú con interior acolchado. Presentación en caja diseño eco.

16 x 4,8 x 10 cm 1 20

E(1), L2





BAMBÚ



### 4078 Shake

Abridor de diseño realizado en madera natural con interior de acero inoxidable y troquel redondo para colgar.

17,9 x 4,1 cm 1/50 100

D(4), L1, W



### 4111 Colins

Abridor de diseño compacto realizado en bambú natural con interior de acero inoxidable y troquel superior para colgar.

10,5 x 1 x 4 cm 1/50 200

D(4), L1



### 4090 Roden

Abridor de acero inoxidable con empuñadura de madera natural.

4 x 14,3 x 2,1 cm 1/50 200

D(4), L1, W



### 4088 Sherry

Abridor imantado de bambú con función posavasos.

1,1 x Ø6 cm 1/50 500

D(4), L1, W





580 ml

### 3993 **Larius**

Set de cóctel en acero inoxidable 304. Incluye vaso medidor, coctelera de 580 ml, colador y cuchara. Bolsa de transporte incluida. Presentación en caja diseño.

29,5 x Ø8,70 cm 1 20

F(1), L2



SET DE COCKTAIL | ACERO INOXIDABLE

# LARIUS



# PREPARA TU MEJOR COCKTAIL

HECHO EN ACERO INOXIDABLE



700 ml

3994 **Daniel**

Coctelera de acero inoxidable con cierre antigoteo de seguridad y tapón dosificador. Capacidad 700 ml. Presentación en caja diseño.

16,1 x Ø8,80 cm

1

40

F(1), L2

3995 **Cardu**

Medidor para bebidas de acero inoxidable. Medidas 15 y 30 ml de capacidad. Presentación en caja blanca.

6,9 x Ø3,90 cm

1/50

200

F(1), L1



175 ml

4141 **Walker**

Petaca de acero inoxidable con cierre antigoteo de seguridad. Capacidad 175 ml. Presentación en caja diseño.

9,3 x 11,2 x 2,1 cm

1/50

100

F(1), L2

NEW.



1040 **Viza**

Set de bolos de madera. 10 bolos y 2 bolas. Incluye bolsa de algodón para fácil transporte. Presentación en caja diseño eco.

32 x 34 cm

1

8

G(1)

# JUEGOS DE MADERA



1014 **Galvy**

Set de 4 juegos de habilidad: mikado, ajedrez, damas y dominó. Presentado en caja con tapa deslizante con función tablero en su interior.

16,6 x 3 x 16,5 cm

1

50

D(2), L2, W











### 1013 **Domis**

Juego de dominó realizado en madera. 28 piezas presentadas en caja con tapa deslizante.

 14,6 x 3 x 5 cm  1/50  100

 D(2), L2, W



### 1016 **Brisca**

Set de 2 juegos de mesa: baraja francesa y dados. Presentado en caja de madera con dos compartimentos y tapa deslizante.

 10 x 2,5 x 9,1 cm  1/50  100

 D(4), L2, W



# NEW NAIPES





**NEW.**



### 1028 **Naipes**

Baraja francesa de cartón reciclado. Incluye 54 cartas. Presentación en caja diseño eco.

 9 x 2 x 6 cm  1/100  200

 D(1)







1035 **Pensy**

Juego 3 en raya realizado en madera. Incluye 10 fichas presentadas en bolsa de algodón natural.

13 x 12 cm 1/10 500

G(1)



1011 **Triwa**

Juego de mesa 3 en raya realizado en madera. 9 bloques presentados en caja con tapa deslizante.

7,5 x 3,2 x 7,5 cm 1/50 200

D(4), L2, W



1010 **Ryman**

Juego de habilidad formado por 45 bloques rectangulares, presentado en bolsa de algodón con cordones.

5,7 x 16,5 x 5,7 cm 1 50

G(1), N(8)



1009 **Rocks**

Set de 3 juegos de habilidad en madera natural. Presentado en caja de madera con compartimentos y tapa deslizante.

16,5 x 6 x 6,4 cm 1 50

D(4), L2, W





NEW.

1041 **Cubik**

Set de Juegos de habilidad. 24 modelos disponibles.

4 x 4 x 4 cm

24

576

C(1)

# CLASSIC GAMES

NATURAL  
WOOD0111 **Leis**

Puzzle Tangram de madera natural con 7 piezas a color.

10,3 x 10,3 cm

1/100

400

E(1), L2



01

29

03

60

05

226

NATURAL  
WOOD0112 **Rosko**

Yoyo de madera natural con cordón de 75 cm.

2,8 x Ø5,50 cm

1/50

400

C(4), W, L1

### 8069 Resol

Set infantil para colorear. Incluye bloc con dibujos variados, 6 lápices de colores, sacapuntas y goma de borrar. Práctica asa de transporte.

20 x 21 x 1,6 cm 1/40 80

D(1)



INCLUYE 20 LÁMINAS

# PENCILSET



03

31

60

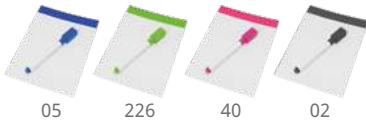

05

226

40

02

### 8047 Lilian

Pizarra y rotulador magnéticos en variados colores. Rotulador de tinta negra con borrador incluido.

10,5 x 15 cm 1/25 200

D(4)

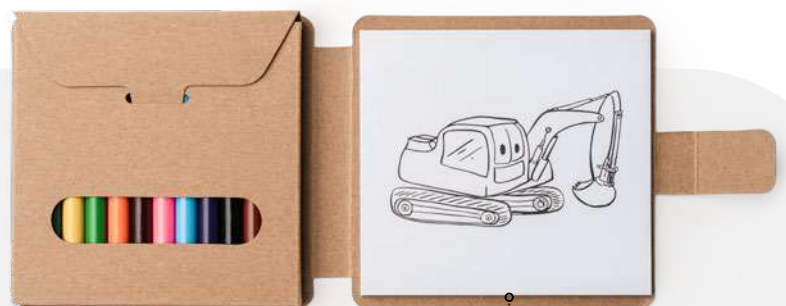

36 LÁMINAS

### 8049 Tilos

Set infantil para colorear. Incluye bloc con dibujos, 6 lápices de colores y sacapuntas. Presentación en caja de cartón reciclado.

7,4 x 1,5 x 9 cm 1/50 400

C(4), W



DIBUJOS PARA COLOREAR

### 8077 Pyrus

Set infantil para colorear. Incluye bloc con dibujos variados de 36 hojas con 12 lápices de colores.

10 x 1 x 9,5 cm 1/50 200

C(4)





### 9131 Pachu

Delantal infantil de non-woven con diseño para colorear. 5 ceras en varios colores incluidas. Talla única ajustable.

43 x 43 cm

1/50

200

F(1)



### 7529 Azor

Bolsa infantil de non-woven con diseño para colorear. Incluye 5 ceras en colores variados.

20,5 x 22 cm

1/50

200

F(1)



### 7530 Turcaz

Mochila infantil de cordones realizada en non-woven, con diseño para colorear. Incluye 5 ceras en colores variados.

25 x 30 cm

1/50

200

G(1)

COLORES INCLUIDOS



**NEW.**



### 7571 Solaz

Estuche infantil de non-woven con diseño para colorear. Incluye 5 ceras de colores variados.

22 x 11 cm

1/50

200

F(1)

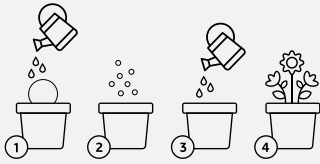

1036 **Girax**

Macetero de terracota con semillas de girasol.  
Incluye sustrato. Fabricado en la UE.

6 x 5 x 5 cm   1   200  
E(1)



HECHO EN  
**EUROPA**

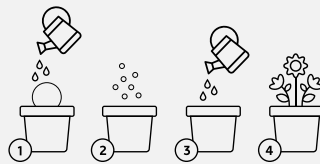

1037 **Tulsy**

Set de dos maceteros con semillas de perejil y albahaca.  
Incluye sustrato. Fabricado en la UE.

12 x 5 x 5 cm   1   100  
E(1)

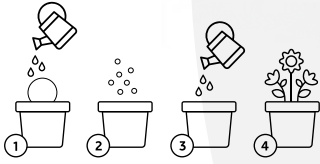

### 1000 **Volen**

Maceta con semillas de petunia y macetero biodegradable. Incluye sustrato.

6,1 x Ø6,40 cm 1/25 200

E(4)



# MACETERO BIODEGRADABLE





### 1314 Citrus

Difusor de aromas y humidificador. Vaporización continua con leds multicolor. Capacidad 130 ml. Cable incluido. Presentación en caja diseño eco.

9,5 x Ø10 cm 1 50  
E(1)

# CHILL & RELAX



BAMBOO

VANILLA SCENT



### 1315 Vanila

Vela aromática en vaso de cristal translucido con tapa de bambú. Aroma vainilla. Presentación en caja diseño eco.

8,8 x Ø7 cm 1 50  
E(1), L2

### 1315 Vanila



### 1313 Surna

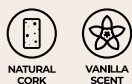

NATURAL CORK

VANILLA SCENT



### 1313 Surna

Vela aromática en recipiente de cristal y tapón de corcho. Aroma vainilla. Incluye tarjeta de cartón kraft para marcaje. Presentación en caja diseño eco.

7,6 x Ø5,60 cm 1/25 100  
E(1)

PERFUMA  
**TU HOGAR**  
ACABADOS NATURALES

# VELAS PARA EL HOGAR

## 1307 King

Vela aromática a vainilla con porta-velas pizarra de cerámica. Incluye tiza blanca. Presentación en caja de cartón Kraft.

7,8 x Ø7 cm



E(1), L1



01

260

60



251

02

## 1306 Flake

Vela aromática a vainilla en vivos colores presentada a juego con porta-velas metálico. Tapa con ventana transparente.

3 x Ø6,30 cm



E(1), L1



## 1311 Kimi

Vela aromática en vaso de cristal de colores y fragancias variadas (café, pino, lavanda, vainilla y fresa). Presentación en caja individual.

6,7 x Ø5,60 cm



F(1), L1



01

03

31

60

05

226

40

02

## 1312 Maka

Vela en soporte de madera con diseños navideños (estrella y árbol). Presentación en caja individual.

8,7 x 2,1 x 8,4 cm



E(1), L1



512



511

# SOPORTES PARA MÓVILES



BAMBOO

## 4094 Stelo

Llavero con función soporte para el móvil realizado en bambú.

6 x 1,4 x 2,6 cm 1/100 500

D(4), L1, W



BAMBOO

## 3010 Lyra

Soporte de bambú natural para móviles. Ranura inferior para cable de carga. Incluye 2 partes de fácil montaje.

8 x 8,1 x 12 cm 1/50 100

D(4), L2, W



BAMBOO

## 3055 Antix

Soporte para dispositivos móviles, tablet o smartphone, realizado en bambú natural.

6 x 2 x 8 cm 1/50 200

D(4), L1, W



BAMBOO

## 4110 Boncer

Llavero de bambú natural con función de soporte para móvil.

8,5 x 2,9 x 0,8 cm 1/100 600

D(4), L1





### 4109 Marbel

Llavero de madera natural en dos formatos con terminaciones en elegante polipiel.

8,5 x 0,5 cm 1/100 800

D(4), L1



982

983



### 4054 Budan

Llavero de madera natural. Especial para grabado láser.

10,4 x 05 cm 1/200 800

D(4), L1



982

983

6x0,3x3,5cm

0,5x05cm



### 4053 Hibis

Llavero de corcho natural.

3,9 x 8,1 cm 1/200 800

D(1), L1



4x0,5x6cm

981

0,5x05cm

982



### 4092 Sila

Llavero de madera natural en dos formatos con anilla metálica. Ideal para marcaje en láser.

7,2 x 03,90 cm 1/100 1000

D(4), L1



3 x 8,8 x 0,6 cm

03,9x0,6cm



### 4108 Yate

Llavero de corcho natural flotante con resistente cuerda en poliéster.

9 x 1,5 x 4 cm 50 400

D(1), L1



02

05



60 05 226 40 251 02

### 4070 Sparkling

Llavero abridor de aluminio.

1,1 x 6,7 x 1,5 cm 1/200 1000

D(4), L1



60 05 226 251 02

### 4071 Stout

Llavero abridor de aluminio con forma de botella.

3 x 8,9 x 0,2 cm 1/100 1000

D(4), L1



31 60 05 226 251 02

### 4074 Malt

Llavero abridor de aluminio.

7,9 x 1,5 cm 1/200 1000

D(4), L1



**NEW.**

### 4207 Bioko

Llavero abridor de aluminio.

6 x 1,5 x 1,1 cm 1/200 1000

D(4),L1



60 05 226 251 02



60 05 226 251 02

### 4072 Lager

Abridor de aluminio de diseño clásico.

3,8 x 8,5 x 0,3 cm 1/100 1000

D(4), L1



60 05 226 251 02

### 4073 Pale

Llavero mosquetón de aluminio.

3 x 5,8 cm 1/200 1000

D(1), L1



01 05 226 02 60

### 4050 Tonic

Llavero con moneda para carro de la compra. Metálico con esmalte a color.

6 x Ø2,30 cm 1/100 1000

D(1)



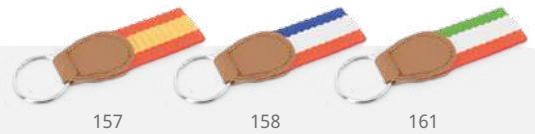

### 4080 Flag

Llavero de poliéster con diseño de bandera y refuerzo de PU.

12 x 3 cm

1/50

400

E(1), L1



01 03 31 60 55 05 226 02

### 4051 Mineral

Llavero metálico con tira de color en poliéster.

2,8 x 6,5 x 0,6 cm 1/50 300

D(4), L1



### 1004 Tresna

Llavero Flexómetro de 1 metro con mecanismo de bloqueo y cuchila metálica.

4,3 x 4,4 x 1,8 cm 1/50 500

D(1), V



### 4079 Sito

Llavero de osito de peluche realizado en suave poliéster con camiseta a color.

6,5 x 7,5 x 4 cm 1/20 500

E(1), N(8)





### 1228 **Seyku**

Pelota anti-estrés realizada en PU de color liso.

📏 Ø6,20 cm

📦 1/20

📦 400

👤 E(1)

**NEW.**  
COLOR



01



60

# ANTI-STRESS



### 1229 **Biku**

Corazón anti estrés realizado en PU de color liso.

📏 7 x 7 x 4 cm

📦 1/20

📦 400

👤 E(1)

**NEW.**



60



05

### 1232 **Dona**

Gota anti estrés realizada en PU de color liso.

📏 8 x Ø6 cm

📦 1/20

📦 400

👤 E(1)

# TOOLS & PET CARE





3984 **Sorby**

Multiherramientas de acero inoxidable. Diseño compacto. 11 funciones. Incluye destornilladores y desmonta cadenas. Presentación en caja diseño.

9,1 x 1,8 x 4,6 cm 1/20 60

E(1), L2



NEWSORBI



TOOLS SET



4127 **Turner**

Set de herramientas con 20 accesorios. Cutter, llaves hexagonales, destornilladores de estrella y planos y herramienta de fijación.

4,9 x Ø12,90 cm 1 30

F(2)





### 8024 **Kanchan**

Bolígrafo multiherramienta 4 en 1: nivel, regla en centímetros y pulgadas, destornillador con cabeza plana y estrella. Cuerpo con acabado metalizado, mecanismo giratorio y clip metálico. Tinta azul.

14,9 x Ø1 cm 1/50 1000  
B(4)

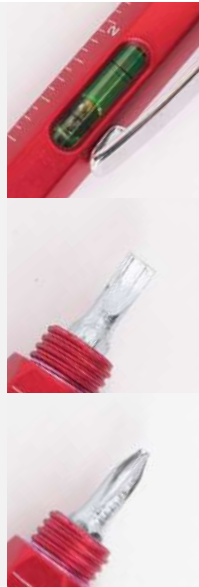

01 60 02 05 251

**NEW.**



60 05 226 02

### 3991 **Brico**

Multiherramienta de aluminio en forma de bolígrafo. Incluye 8 cabezales de destornillador, estrella y planos.

11 x Ø1,30 cm 1/50 200  
C(1), L1



01 03 60 05 226

### 0108 **Lock**

Cutter de cuchilla ancha y cuerpo de ABS. Agarre ergonómico troquelado y capucha extraíble para el corte y ajuste de la cuchilla.

3 x 15,5 x 1,4 cm 1/100 500  
C(4)



### 8088 Veta

Lápiz de carpintero en forma ovalada para un fácil marcaje. Punta sin afilar.

17,6 x 1,2 cm

100

1000

A(4), L1

29 60 05 02



### 8003 Mata

Mini lápiz de madera en acabado natural con goma. Cuerpo redondo.

10 x Ø0,50 cm

100

2000

A(4)



PPE

### 9921 Franklin

Gafas transparentes anti-vaho. Patillas con ventilación lateral, realizadas en ligero policarbonato.

15,5 x 5,7 x 15 cm

1/10

200

D(4)



01



02

### 0104 Sherlock

Lupa cuentahilos plegable de 8 aumentos, con regla de medición integrada en el cuerpo. Presentación en caja individual.

4,5 x 4,5 x 1,4 cm

1/50

400

C(4)

# SHERLOCK



PICK

RIVET



01 03 60 05 226

5M

0106 **Pick**

Fléxometro de 5 metros homologado, con mecanismo de bloqueo y cuchilla metálica. Cuerpo en color con funda de goma, clip metálico y cinta de transporte. Presentación en caja individual.

7 x 3,5 x 7 cm 1/10 50

E(1)



01 03 60 05 226

3M

0105 **Rivet**

Fléxometro de 3 metros homologado, con mecanismo de bloqueo y cuchilla metálica. Cuerpo en color con funda de goma, clip metálico y cinta de transporte. Presentación en caja individual.

6,5 x 3 x 6 cm 1/10 50

E(1)

WORK ACCESSORIES

**NEW.**

**NEW.**



BAMBÚ

1026 **Dovel**

Flexómetro de 5 metros. Con mecanismo de bloqueo y cuchilla metálica. Clip metálico, cinta de transporte y detalles en bambú. Presentación en caja diseño eco.

6,5 x 6,5 x 3,1 cm 1/30 60

E(4), L1

3983 **Dintel**

Escalímetro de aluminio con diseño triangular de 30 cm. Escalas 1:20, 1:25, 1:50, 1:75 y 1:100. Una cara lisa especial para marcaje. Presentación en caja blanca.

32 x 2 x 2 cm 1/50 200

F(4), L1



LUZ 3 POSICIONES



01 60 05 226 02

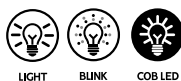

0110 **Flash**

Linterna deportiva multiusos con cinta para ajuste. 8 luces LED COB con 3 modos de iluminación. 3 Pilas AAA no incluidas. Presentación en caja individual.

6,1 x 4 x 1,7 cm 1/100 500

E(1)



CARGA MANUAL



03 60 05 226 02

0107 **Brill**

Linterna con 3 luces LED y carga manual. Disponible en varios colores translúcidos, con cinta de transporte en color gris a juego con el pulsador. Presentación en caja individual.

10,5 x 5 x 2,5 cm 1/25 200

D(4), V

# ALWAYS WITH LIGHT



60 05 251 02

8023 **Araya**

Bolígrafo linterna de luz LED con cuerpo de ABS metalizado. Mosquetón integrado en la capucha. Tinta azul.

11 x Ø1 cm 1/50 500

B(4)



60 05 251 02

0109 **Hale**

Linterna de aluminio en acabado metalizado con 1 LED. Mosquetón de transporte a juego y pilas de botón incluidos.

6 x Ø1,50 cm 1/100 600

D(4), L1



3990 **Goliath**



3989 **Vidur**



3988 **Kaide**



NEW  
KNIVES





NEW.



NEW.



NEW.



BAMBOO



### 3988 Kaide

Navaja de acero inoxidable con empuñadura de bambú natural. Incluye cinta para transporte. Presentación en caja diseño eco.

9,7 x 2,5 x 1,1 cm 1/10 250

E(4), L1



NATURAL WOOD



### 3989 Vidur

Navaja de acero inoxidable y empuñadura combinada con madera natural. Sistema de seguridad. Presentación en caja diseño eco.

9,1 x 2,4 x 1,4 cm 1/10 100

E(4), L1



NATURAL WOOD



### 3990 Goliat

Navaja de acero inoxidable con hoja en color negro y empuñadura de madera natural. Sistema de seguridad. Presentación en caja diseño eco.

9 x 2,6 x 1,2 cm 1/10 100



E(4), L1



BAMBOO

### 4120 **Murdok**

Multiherramienta con cuerpo y accesorios en acero inoxidable y empuñadura de bambú. 12 funciones: navaja, sierra, limas, abridores, destornilladores y alicates. Incluye cinta para transporte. Presentación en caja eco.

 5 x 1,7 x 10,5 cm  1/10  100

 E(4), L1



# BINTAL



## 4096 Bintal

Navaja multiusos con accesorios en acero inoxidable y cuerpo de bambú. 9 funciones. Incluye cinta para transporte en polipiel. Presentación en caja eco.

9 x 1,6 x 2,3 cm 1/50 100

E(4), L1

..... 9 FUNCIONES



## 4095 Zora

Navaja multiusos de acero inoxidable con 6 funciones: cuchillo, abridor, abrelatas, descorchador, destornillador y llavero. Presentación en caja blanca.

7,6 x 2,1 cm 1/20 200

E(4), L1

# ZORA



..... 9 FUNCIONES





# 4 COLORES

DIFERENTES OLORES

## 1316 Rindal

Ambientador de diferentes aromas en bote de cristal con tapón de madera y cordón de ajuste a juego. Capacidad 5 ml. Presentación en caja transparente.

4,8 x Ø2,30 cm 1/100 400  
D(4)

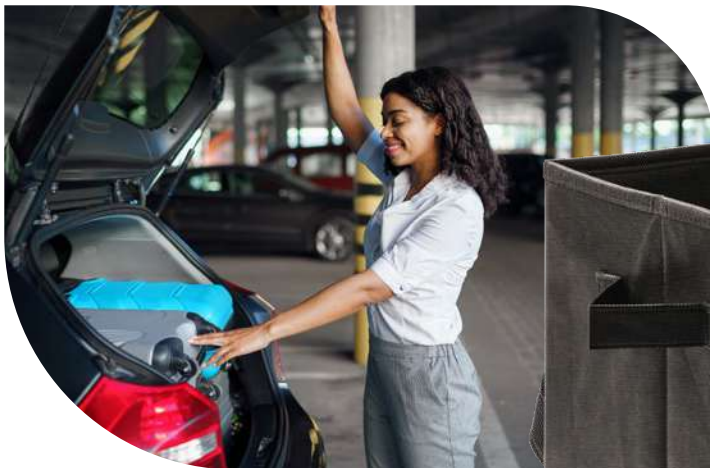

## 7169 Rifter

Organizador de maletero para coche en resistente non-woven. Asas de transporte reforzadas, asas laterales y bolsillo frontal. Base rígida para un mejor ajuste.

34 x 28 x 25 cm 1 40  
G(1), N(8)

# ORGANIZADOR DE VIAJE



### 4128 Nisek

Rascador de hielo con manopla forrada en poliéster 210T.

25 x 1,5 x 17 cm 20 100  
E(1), N(8)

# RASCADORES DE HIELO



### 4142 Alsen

Rascador de hielo de diseño compacto. Un lado en acabado en sierra y dos lisos.

11 x 11,7 x 0,2 cm 50 600  
D(2)



### 4143 Nosok

Rascador de hielo realizado en bambú con un lado de acabado en sierra y otro liso. Presentado en bolsa de papel eco.

12,4 x 0,6 x 10,8 cm 1/50 200  
E(1)



# SEGURIDAD & PREVENCIÓN



EN ISO 13688:2013  
EN ISO 20471:2013/A1:2016  
**CLASS 2**

## 5063 **Sirio**

Chaleco alta visibilidad de cuello pico. Con dos bandas reflectantes en pecho y espalda. Cierre de velcro ajustable.

Certificación CE según las normas:  
EN ISO 13688:2013/A1:2021 Y EN ISO 20471:2013/A1:2017.  
Clase II.





 1  100

**NEW.**



## 5627 **Gante**

Manta térmica para actividades deportivas. Impermeable y cortavientos. Interior de aluminio

 210 x 130 cm  1/50  200  
 D(1)





# PARASOLES



## 1007 **Mack**

Set de 2 parasoles plegables para ventanilla. Incluye ventosas de sujeción. Presentación en funda de PVC.

44 x 38 cm

1/25

100

F(1)

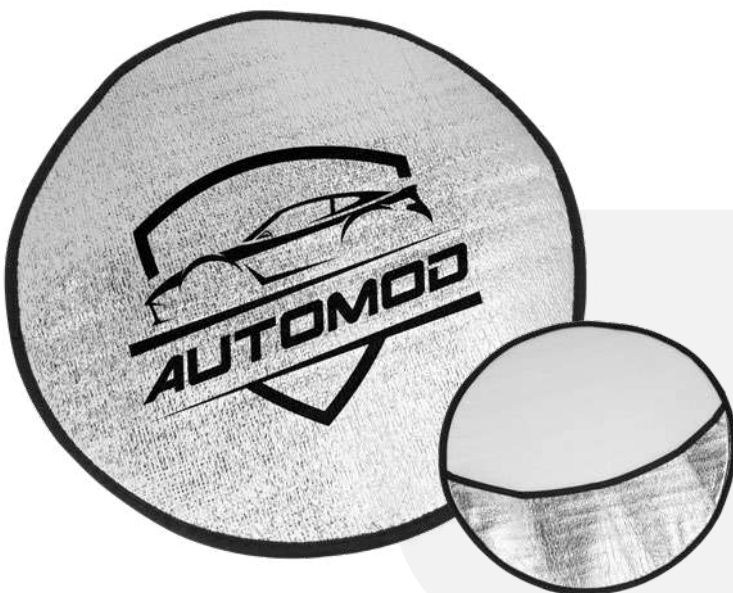
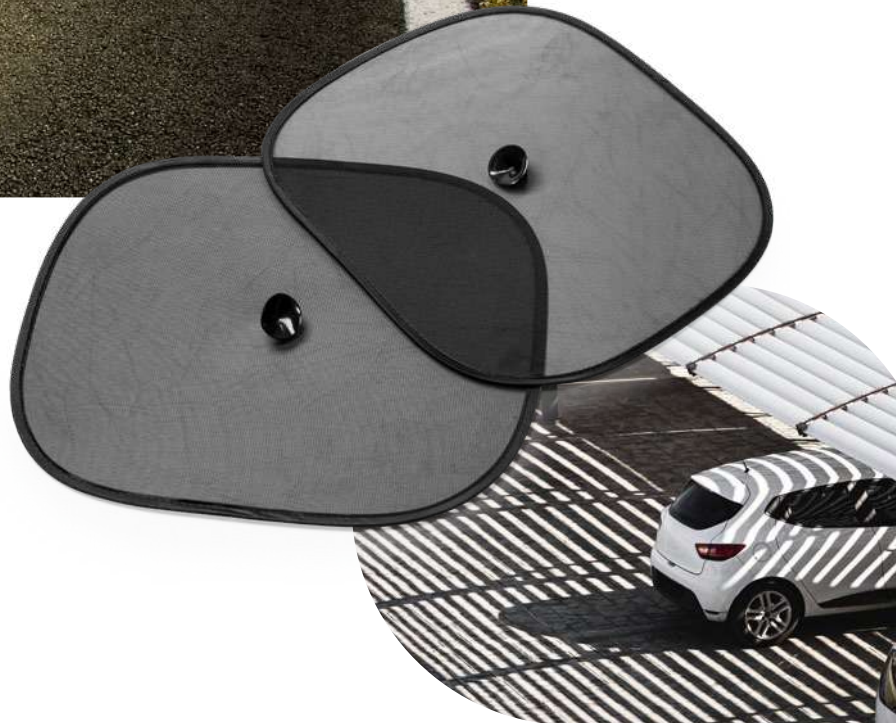

## 0103 **Bora**

Cubre volante redondo con capa frontal en aluminio metalizado. Ribete en color negro. Presentación en plano.

Ø44 cm

200

F(1)

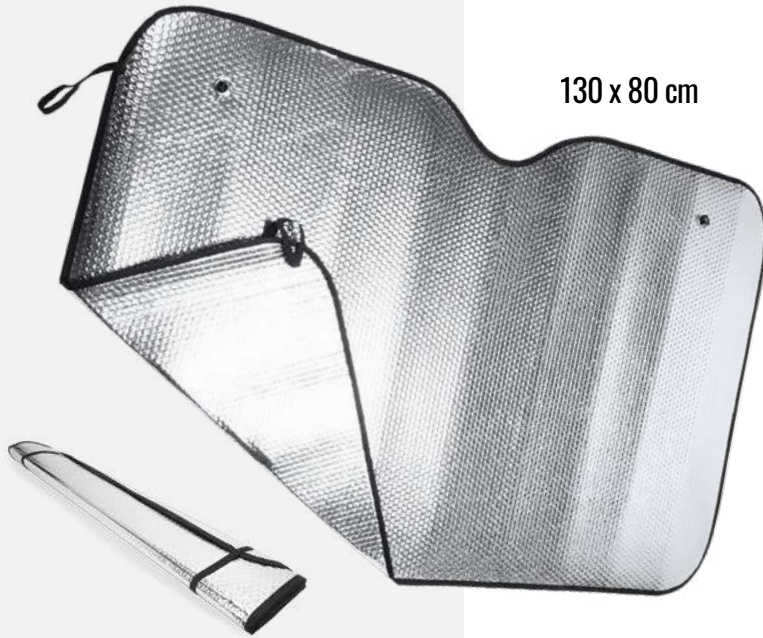

130 x 80 cm

**0102 Batur**

Parasol tamaño maxi con burbuja a doble cara realizado en aluminio acabado metalizado y ribete en poliéster. Argollas metálicas con ventosas y cintas elásticas para plegado incluidas. Presentación en plano.

 130 x 80 cm

 100

 G(1)

180 x 90 cm



# PARASOL PARA CAMIÓN

**1017 Columbia**

Parasol de grandes dimensiones ideal para camiones y furgonetas. Burbuja a doble cara, realizado en aluminio acabado metalizado y ribete en negro. Incluye argollas metálicas con ventosas y cintas elásticas para plegado. Presentación en plano.

 180 x 90 cm

 50

 G(1)



150 x 70 cm

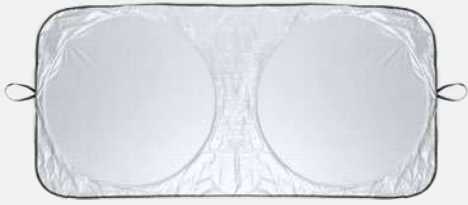

1008 **Prisma**

Parasol plegable de poliéster 170T. Incluye práctica funda a juego.

150 x 70 cm 1/50 100  
G(1)



INCLUYE FUNDA



130 x 65 cm

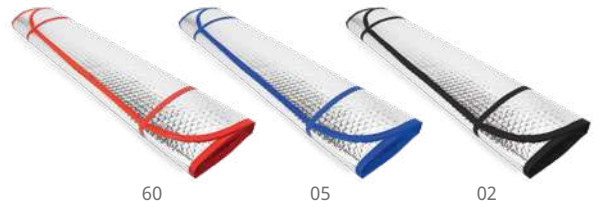
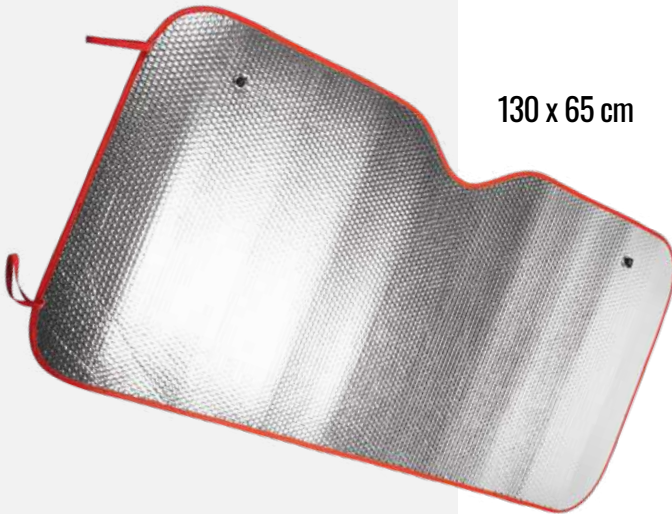

60

05

02

0101 **Kini**

Parasol con burbuja a doble cara realizado en aluminio acabado metalizado y ribetes en color. Argollas metálicas con ventosas y cintas elásticas para plegado incluidas. Presentación en plano.

130 x 65 cm 100  
G(1)

130 x 60 cm

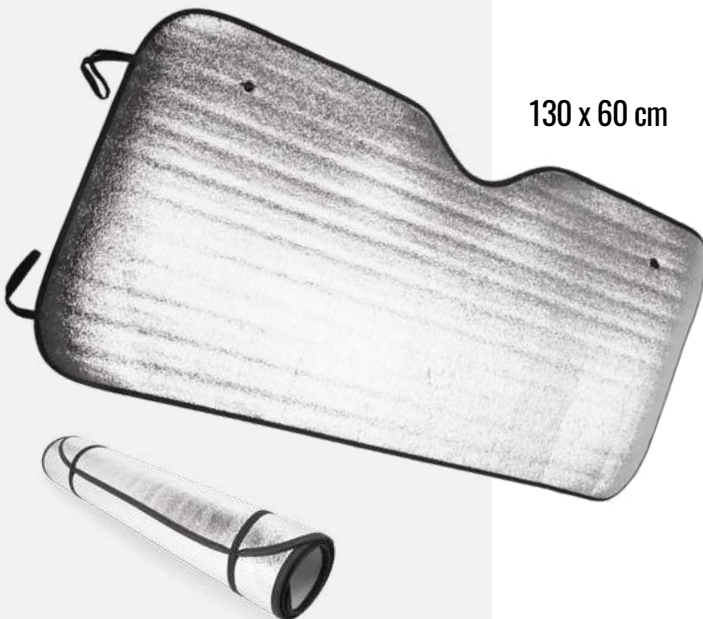

0100 **Akala**

Parasol con frontal en aluminio de acabado metalizado, ribete de poliéster y argollas metálicas reforzadas. Ventosas de sujeción y gomas elásticas para plegado incluidas. Presentación en plano.

130 x 60 cm 100  
G(1)







60

05

02

### 1021 **Korat**

Collar para mascotas en resistente y suave poliéster. Cinta ajustable y hebilla con cierre de clic. Incluye anilla metálica para correa de paseo.

 51 x 2,5 cm  1/20  300

 F(1)

# PET CARE

LO MEJOR PARA TU COMPAÑERO



01

03

31

60

05

226

02

### 1018 **Simba**

Dispensador de bolsas para mascotas con mosquetón de transporte a juego. Incluye 15 bolsas.

 8,2 x 4,1 x 5,4 cm  1/50  200

 D(4)





60

05

226

### 1019 Shira

Bowl plegable para mascotas. Apto para líquidos y sólidos. Capacidad 450ml. Incluye mosquetón metálico para transporte a juego.

5,2 x Ø12,90 cm 1/50 200

L2



NEW.



29



RECYCLED PET

### 1024 Muntok

Bowl plegable para mascotas. Realizado en RPET y papel reciclado. Apto para líquidos y sólidos. Capacidad 1,3L.

10 x Ø17 cm 1/10 200

F(1)



03

60

05

### 1020 Lanza

Pelota para mascotas en resistente goma y tejido reforzado.

Ø6,40 cm 1/20 200

N(8), L1



NEW.



RECYCLED PET

### 1025 Demak

Frisbee para mascotas con tejido central de RPET y cuerda de algodón.

Ø20 cm 1/10 100

F(1), N(8), R



01

60

05

# WINTER & RAINY DAYS



130x165 cm



POLAR FLEECE | SHERPA

GLORY



06

55

47

5626 **Glory**

Manta polar de estilo Sherpa con polar fleece de 380 g/m<sup>2</sup>. Incluye tarjeta ideal para marcaje y cinta de color a juego.

130 x 165 cm

1

10

F(1), N(8), O, P



# 100% RECYCLED POLYESTER



## 5624 Brandon

Manta de forro polar realizada en poliéster reciclado RPET con práctica funda. Tratamiento anti-pilling. 200 g/m².

150 x 120 cm 1 20  
G(1), H(1), N(8), O, P



TRANSPIRABLE



## 5622 Bering

Manta de forro polar con práctica funda a juego en acabado Oxford con rejilla. Tratamiento anti-pilling. 100% poliéster de 200 g/m².

130 x 160 cm 1 20  
G(1), H(1), N(8), O, P



60 05 55 226 58 02



ANTIPILLING

### 5625 Daneris

Manta de forro polar con tratamiento anti-pilling. Incluye asa de transporte con cierre de velcro. 100% poliéster de 200 g/m<sup>2</sup>.

 160 x 130 cm

 1

 25

 F(1), N(8), O, P



31

60

05



226

58

02



ANTIPILLING

### 5621 Lambert

Manta de forro polar con tratamiento anti-pilling. 100% poliéster de 180 g/m<sup>2</sup>.

 120 x 150 cm

 1

 20

 N(8), O, P







FORRO POLAR

IMPERMEABLE



REVERSIBLE



07

15

55

02

### 6998 Frosty

Gorro estilo bob reversible. Exterior de nylon e interior en forro polar.

Ø60 cm

25

100

F(1), N(8), O



PROLY

ANN REFORMS



01

60

55

05

02

### 9009 Planet

Gorro de punto con doble vuelta, especial para bordado. 100% acrílico. Etiqueta removible.

10

200

N(8), O, P



06

60

05

55

107

40

58

02

### 6997 Bulnes

Gorro de punto fabricado en poliéster de doble capa. Banda frontal a juego ideal para marcaje.

22 x 21 cm

1/10

200

E(1), N(8)



56 56 58 02

### 9947 Delun

Braga multiusos realizada en algodón orgánico de 150 g/m<sup>2</sup>

25 x 50 cm 1/10 100

G(1), N(8), O, P



### 2009 Nukka

Braga gorro en acabado polar con ajustador elástico. 100% poliéster polar 210 g/m<sup>2</sup>.

30 x 25 cm 10 100

G(1), N(8), O, P, R



SUBLIMABLE



01 03 31 60 55  
05 226 02 78

### 9004 Nanuk

Braga para cuello multifunción de diseño tubular y corte recto. 100% poliéster tacto algodón de 130 g/m<sup>2</sup>.

25 x 50 cm 25 500

G(1), N(8), R



05 226 58 60 02

### 5623 Zeland

Guantes táctiles (dedos pulgar, índice y corazón). Zona táctil en diferente color al resto del guante. Talla única adulto. Fabricado en acrílico.

21 x 11,5 cm 1/10 200

N(8)



03



60



05

### 5600 **Damper**

Poncho impermeable plegable, con capucha y apertura para los brazos, acabado termosellado y cierre lateral con conorchetes. Talla única 127 x 100 cm. Fabricado en PVC. Funda incluida.

22,5 x 18 cm

1

50

F(1), H(1)

# RAINY DAYS



01



03



60



05

INCLUYE FUNDA

### 5603 **Baikal**

Chubasquero impermeable con acabados termosellados, cierre central con 4 corchetes, bolsillos laterales con tapeta, puños con botón ajustador, 3 aberturas de ventilación en la espalda y capucha ajustable con cordón. Talla única adulto. Funda incluida.

86 x 72 cm

1/10

50

F(1)







### 5602 **Vostok**

Poncho impermeable compostable con capucha y abertura para los brazos. Talla única de adulto: 127 x 102 cm. Fabricado en poliláctido (PLA). Presentación en funda individual de PLA.

127 x 102 cm   1/50   200

E(1)



01   03   60   05   226

### 5601 **Shaka**

Poncho impermeable plegable con capucha y abertura para los brazos. Talla única de adulto: 127 x 102 cm. Fabricado en polietileno de baja densidad (LDPE). Presentación en funda individual.

127 x 102 cm   1/50   200

E(1)

# DISCOVER OSAKA

NEW AUTO-OPENING UMBRELLA



23 55 02

## 5998 Osaka

Paraguas realizado en tejido pongee 190T con mango en acabado suave. Apertura automática. Varillas de fibra de vidrio con sistema anti-viento y terminaciones reforzadas.

82 x Ø107 cm 1 25

G(1), N(8)



WINDPROOF

## 5609 Harul

Paraguas XL de poliéster 190T con mango, bastón y terminaciones en negro. Varillas largas de fibra de vidrio con sistema anti-viento. Botón de apertura automática. Mango de EVA. Cierre con velcro a juego.

98 x Ø130 cm 1 25

G(1), N(8), R

SUBLIMABLE



01 60 55 05 02



SUBLIMABLE



Ø105

01 60 05 226 02 0102

### 5611 Fargo

Paraguas con mango en madera y apertura automática. Varillas y terminaciones en negro. Cierre con velcro. Fabricado en poliéster 190T.

85 x Ø105 cm 1 40  
G(1), N(8), R

MANGO MADERA



Ø105



01 03 31 60 05 226 02

### 5608 Milford

Paraguas con tela y mango a juego. Varillas y terminaciones en negro. Cierre con velcro y apertura automática. Fabricado en poliéster 190T.

83 x Ø105 cm 1 25  
G(1), N(8), R



SUBLIMABLE

NEW.  
COLOR



Ø105

01 60 55 05 226 02 63

### 5607 Lyse

Paraguas con mango, bastón y terminaciones en madera. Varillas en negro. Cierre con velcro a juego. Apertura manual. Fabricado en poliéster 190T.

90 x Ø105 cm 1 25  
G(1), N(8), R







**NEW.**



01 55 46 02



**5605 Miyagi**

Paraguas plegable de apertura automática. Tejido pongee 190T con funda a juego. Mango de EVA y varillas metálicas en negro.

☞ Ø98 cm

☞ 1

☞ 30

☞ G(1), N(8), R

**APERTURA & CIERRE AUTOMÁTICO**



01 60 55 02

**5999 Nauro**

Paraguas de apertura y cierre automáticos. Tejido pongee 190T con funda a juego. Varillas y terminaciones en negro con mango de bambú. Cierre con velcro a juego.

☞ 57 x Ø100 cm

☞ 1

☞ 30

☞ G(1), N(8), R





5606 **Yaku**



Paraguas plegable de apertura manual con funda a juego. Mango, varillas y contera plateados. Cierre con velcro. Fabricado en poliéster 190T.

24 x Ø5 cm

1

60

G(1), N(8), R

SUBLIMABLE

**NEW.**  
COLOR



01 03 31 60 05 226 02 40 63

# 100% POLIÉSTER RECICLADO

SUBLIMABLE



01 60 05 02



WINDPROOF



5610 **Khasi**

Paraguas plegable de poliéster reciclado 190T RPET con funda a juego. Bastón, varillas y terminaciones en negro. Mango de madera natural. Cierre con velcro a juego y apertura manual.

27,5 x Ø5,80 cm

1

50

G(1), N(8), L2



MANGO MADERA

# SUBLIMATION



7618 **Miso**

Bolsa ideal para sublimación. Realizada en suave y resistente poliéster. Asas largas de 70 cm.

42 x 38 cm

10

100

F(6), N(8), R

# POLIESTER CON TACTO ALGODÓN

7569 **Osak**

Neceser ideal para sublimación. Realizada suave poliéster con forro interior. Cremallera con tirador a juego.

22 x 14 x 6,5 cm

1/25

500

F(1), N(8), R

7180 **Kanda**

Mochila de cordones ideal para sublimación. Realizada en suave y resistente poliéster.

42 x 34 cm

10

100

F(1), N(8), R

7114 **Hamelin**

Mochila de cordones con ojales metálicos, realizada en poliéster 210D. Etiqueta removible.

34 x 42 cm

50

300

F(1), N(8), R

7152 **Ninfa**

Mochila de cordones con esquinas reforzadas realizada en poliéster 210D. Bolsillo frontal con cremallera y salida para cables. Etiqueta removible.

34,5 x 45 cm

10

200

F(1), N(8), R

7550 **Larus**

Mochila de cordones realizada en suave poliéster reciclado 210D con esquinas reforzadas.

34 x 42 cm

50

300

F(1), R

7154 **Sison**

Mochila ligera y compacta, en resistente poliéster 600D. Bolsillo frontal con apertura vertical y acolchado en espalda y tirantes. Etiqueta removible.

23 x 40 x 12 cm

1

50

F(1), N(8), O, R



### 7127 Trento

Bolsa sublimable de non-woven de 80 g/m<sup>2</sup> con resistentes asas troqueladas y acabado termosellado. Ideal para sublimación.

34 x 43 cm

20

400

F(1), N(8), R



### 7527 Mito

Bolsa de la compra en non-woven cosido con asas reforzadas. Ideal para sublimación. Asas de 70 cm.

36 x 40 cm

50/50

250

F(1), N(8), R



### 8110 Cloud

Funda para gafas con cordones autocierre. Poliéster de tacto suave.

9 x 18 cm

50

1000

D(1), N(8), R



### 7549 Pantala

Bolsa de la compra plegable realizada en suave poliéster reciclado 210T. Práctico bolsillo para su plegado incluido.

33 x 46 x 8 cm

20

400

F(1), G(1), R

### 7522 Toco

Bolsa de la compra plegable de suave poliéster 190T en acabado cosido. Incluye práctica banda elástica para su plegado.

42,5 x 38 x 7 cm

1/20

400

F(1), G(1), H(1), R





800ml

### 4144 Magun

Bidón de acero inoxidable 304 en acabado sólido. Capacidad 800 ml. Presentación en caja diseño.

22,5 x Ø7,40 cm 1 40  
F(1), L2, L3, Q

DOUBLE WALL

600ml

### 4139 Torke

Bidón termo de acero inoxidable 304 doble pared. Capacidad 600 ml. Presentación en caja diseño.

26 x Ø6,90 cm 1 30  
F(1), L2, L3, Q



BAMBOO

DOUBLE WALL

620ml

### 4039 Boina

Bidón de acero inoxidable 304 y bambú. Capacidad 620 ml. Presentación en caja diseño.

21 x Ø7,30 cm 1 50  
F(1), L2, Q

700ml

### 4200 Selby

Bidón de acero inoxidable 304 especial para sublimación. Capacidad 700 ml. Presentación en caja diseño.

25,7 x Ø7,10 cm 1 40  
L2, L3, Q

DOUBLE WALL

500ml

### 4059 Copo

Bidón termo de acero inoxidable 304 con doble pared especial para sublimación. Capacidad 500 ml. Presentación en caja diseño.

25,5 x Ø7,30 cm 1 24  
L2, L3, Q





4122 **Balax**

Bidón térmico de acero inoxidable 304. Doble pared con aislamiento de cobre. Capacidad 550 ml. Presentación en caja diseño.

22,5 x Ø7,40 cm 1 30  
F(1), L2, L3, Q

4126 **Fancy**

Bidón térmico de acero inoxidable 304. Doble pared con aislamiento de cobre. Capacidad 500 ml. Presentación en caja diseño.

26,3 x Ø7 cm 1 30  
F(1), L2, L3, W, Q

4045 **Athletic**

Bidón de aluminio con mosquetón. Capacidad 400 ml. Presentación en caja diseño.

17,5 x Ø6,60 cm 1 50  
F(1), L2, Q



4049 **Baobab**

Bidón de aluminio con mosquetón. Capacidad 800 ml. Presentación en caja diseño.

24,6 x Ø7,30 cm 1 50  
F(1), L2, L3, W, Q

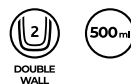

4123 **Salvia**

Termo de acero inoxidable 304 con doble pared. Acabado brillo. Capacidad 500 ml. Presentación en caja diseño.

24,5 x Ø6,90 cm 1 30  
F(1), L2, L3, Q

**NEW.**



3986 **Adaya**

**NEW.**



4148 **Puket**



4040 **Camu**



4098 **Kaster**



4060 **Kaffir**



3986 **Adaya**

Jarra de cristal borosilicato efecto hielo especial sublimación. Capacidad 500 ml. Presentación en caja blanca.



4148 **Puket**

Vaso de cristal borosilicato efecto hielo especial sublimación. Capacidad 330 ml. Presentación en caja blanca.



4040 **Camu**

Bidón de cristal de 500 ml. Funda y cinta de transporte a color. Presentación en caja diseño.

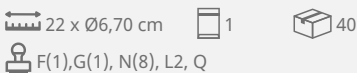

F(1), G(1), N(8), L2, Q



4060 **Kaffir**

Taza de cristal de 340 ml. Especial para sublimación. Presentación en caja eco.



F(1), Q



4098 **Kaster**

Bidón de cristal de 600 ml. Incluye funda a color con asa para transporte. Presentación en caja diseño.



F(1), N(8), L2, R



# PREMIUM QUALITY

3999 **Lemon**



350 ml

3999 **Lemon**

Taza de cerámica de alta calidad de 350 ml especial para sublimación. No incluye caja individual. Presentación en caja de 36 unidades.

9,6 x Ø8,20 cm



4000 **Lima**



4003 **Rambu**



4084 **Marang**



ACABADO MATE

350 ml

4003 **Rambu**

Taza de cerámica de 350 ml con diseño en acabado mate. Especial para sublimación. Presentación en caja blanca.

9,6 x Ø8,20 cm



350 ml

4000 **Lima**

Taza de cerámica de 350 ml especial para sublimación. Presentación en caja blanca.

9,6 x Ø8,20 cm



250 ml

4084 **Marang**

Taza de cerámica de 250 ml, especial para sublimación. Presentación en caja blanca.

8,4 x Ø7,40 cm



700ml

3987 **Samui**

Jarra de cerámica con acabado brillante especial sublimación. Capacidad 700ml. Presentación en caja blanca.

13,8 x Ø10,40 cm 1

20



NEW.



NEW  
SAMUI



0160

0105

0102

300ml

4002 **Kumbo**

Taza de cerámica con diseño retro especial para sublimación. Capacidad 300 ml. Presentación en caja blanca.

8,5 x Ø8,70 cm 1

36



380 ml

### 4014 Damasco

Taza metálica de estilo retro especial para sublimación. Capacidad 380 ml. Presentación en caja blanca.

7,9 x Ø8,80 cm 1 48

L2, Q



MAGIC  
MUGS



350 ml

### 4085 Okra

Taza mágica de cerámica en acabado mate. 350 ml de capacidad. Vierte líquido caliente en ella y descubre el diseño escondido. Presentación en caja blanca.

9,6 x Ø8,20 cm 1 36

F(1), Q



350 ml

### 4001 Mango

Taza de cerámica de 350 ml especial para sublimación. Interior y asa en color. Presentación en caja blanca.

9,6 x Ø8,20 cm 1 36

Q



0103

0131

0160

0105

01226

0102





Ø105

### 5611 Fargo

Paraguas con mango en madera y apertura automática. Varillas y terminaciones en negro. Cierre con velcro. Fabricado en poliéster 190T.

85 x Ø105 cm 1 40

G(1), N(8), R



Ø105

### 5607 Lyse

Paraguas con mango, bastón y terminaciones en madera. Varillas en negro. Cierre con velcro a juego. Apertura manual. Fabricado en poliéster 190T.

90 x Ø105 cm 1 25

G(1), N(8), R



Ø105

### 5608 Milford

Paraguas con tela y mango a juego. Varillas y terminaciones en negro. Cierre con velcro y apertura automática. Fabricado en poliéster 190T.

83 x Ø105 cm 1 25

G(1), N(8), R



WINDPROOF

Ø130

### 5609 Harul

Paraguas XL de poliéster 190T con mango, bastón y terminaciones en negro. Varillas largas de fibra de vidrio con sistema anti-viento. Botón de apertura automática. Mango de EVA. Cierre con velcro a juego.

98 x Ø130 cm 1 25

G(1), N(8), R



Ø95

### 5606 **Yaku**

Paraguas plegable de apertura manual con funda a juego. Mango, varillas y contera plateados. Cierre con velcro. Fabricado en poliéster 190T.

24 x Ø5 cm 1 60  
G(1), N(8), R



Ø95



WINDPROOF

### 5610 **Khasi**

Paraguas plegable de poliéster reciclado 190T RPET con funda a juego. Bastón, varillas y terminaciones en negro. Mango de madera natural. Cierre con velcro a juego y apertura manual.

27,5 x Ø5,80 cm 1 50  
G(1), N(8), L2



Ø100

### 5999 **Nauro**

Paraguas de apertura y cierre automáticos. Tejido pongee 190T con funda a juego. Varillas y terminaciones en negro con mango de bambú. Cierre con velcro a juego.

57 x Ø100 cm 1 30  
G(1), N(8), R



Ø98



### 5605 **Miyagi**

Paraguas plegable de apertura automática. Tejido pongee 190T con funda a juego. Mango de EVA y varillas metálicas en negro.

Ø98 cm 1 30  
G(1), N(8), R

2998 **Sonic**

Alfombrilla de escritorio tamaño XL. Superficie de suave poliéster especial para sublimar y base antideslizante. Presentación individual.

 70 x 35 cm  1/10  30

 F(1), R

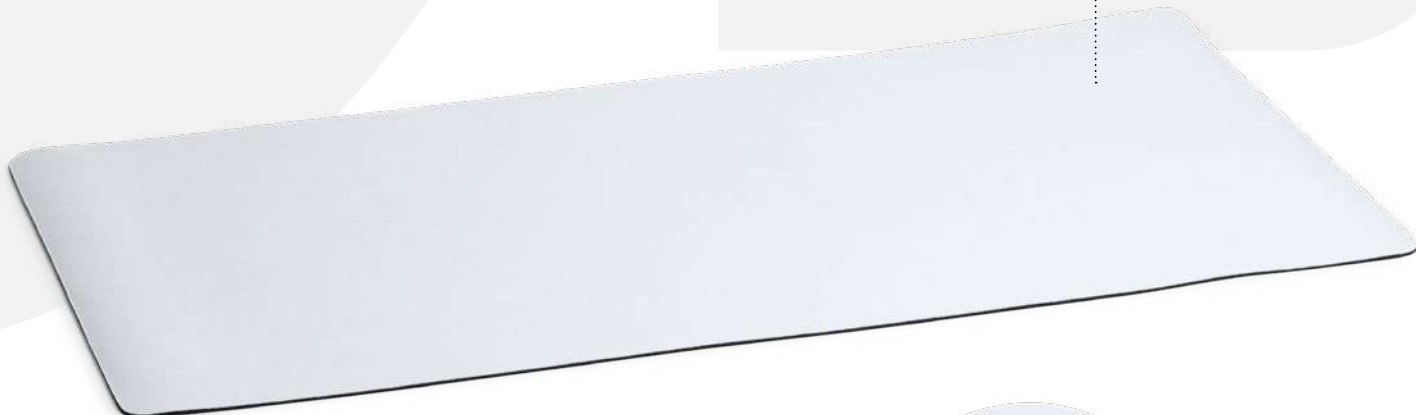

3011 **Sira**

Alfombrilla para ratón de diseño plano. Superficie de poliéster suave y base antideslizante de goma.

 22 x 18 cm  1/100  200

 E(1), N(8), R



3012 **Silvano**

Alfombrilla para ratón realizada en poliéster suave con reposamuñecas acolchado. Base antideslizante de goma.



 20,5 x 24,3 x 2 cm  1  100

 E(1), N(8), R



2997 **Yuba**

Alfombrilla para ratón de formato redondo. Superficie de suave poliéster y base antideslizante.

 Ø20 cm  1/100  200

 E(1), N(8), R





3097 **Areta**

Pulsera ajustable de poliéster especial para sublimación.

30 x 1,5 cm  10000



CIERRE DE SEGURIDAD

3095 **Spring**

Pulsera ajustable de poliéster especial para sublimación.

30 x 1,5 cm  10000



3096 **Paradis**

Pulsera sin cierre de poliéster especial para sublimación.

30 x 1,5 cm  10000



- Impresión en sublimación incluida  
- Pedido mínimo 250pcs



4124 **Kendal**

Llavero con tiras de poliéster especial para sublimación.

12 x 2 cm  2000



7071 **Sinatra**

Lanyard de poliéster doble con mosquetón especial para sublimación.

100 x 2 cm  100  500



7049 **Elvis**

Lanyard de poliéster con mosquetón especial para sublimación.

50 x 2 cm  100  500



### 7050 Calisto

Gorra de RPET con 5 paneles. Cierre de velcro ajustable.

Ø60 cm

25/75

300

F(1), N(8), O, P, R



### 7000 Basica

Gorra de 5 paneles con orificios de ventilación bordados y cierre de velcro ajustable.

25

300

Consultar



### 7048 Wizer

Visera deportiva de poliéster. Con cierre de velcro y laterales acolchados.

25

200

F(1), N(8), O, P, R



### 7020 Mercury

Gorra técnica de 3 paneles. Tejido ligero y transpirable con cierre de velcro ajustable. 90% poliéster y 10% elastano de 40 g/m². Etiqueta removible

25

200

F(1), N(8), O, P, R



### 7057 Kelsey

Toalla absorbente realizada en microfibra 185 g/m². Incluye funda de transporte con cierre ajustable.

100 x 50 cm

1

100

G(1), N(8), O, P, R



### 7103 Bay

Toalla absorbente realizada en microfibra de 345 g/m². Funda reutilizable de PVC incluida.

45 x 30 cm

1

100

F(1), N(8), O, P, R



### 7119 Cork

Toalla multi-deporte de microfibra con práctica banda elástica para su fácil plegado. Secado rápido. 90% poliéster y 10% poliamida de 190 g/m². Etiqueta removible.

70 x 120 cm

10/10

100

F(1), N(8), O, P, R



### 9001 **Crossfitter**

Cinta deportiva en tejido técnico transpirable. 100% poliéster de 140 g/m<sup>2</sup>.

22,5 x 8 cm 10/10 300  
G(1), N(8), R



### 7104 **Olympia**

Cinta elástica deportiva para la cabeza realizada en suave microfibra.

23,5 x 6 cm 1/100 800  
G(1), N(8), R



### 7105 **Speed**

Muñequera elástica realizada en suave microfibra. Bolsillo con cierre de cremallera incorporado.

10 x 9 cm 1/100 1000  
E(1), N(8), R



### 9129 **Ducasse**

Delantal largo de popelín. Cinta a tono en cuello. Cintas laterales para lazada. Dos bolsillos frontales, uno interior y uno grande superpuesto.

· Medida delantal: 90 x 65 cm  
· Medidas de bolsillo: 25 x 16 cm.

65 x 90 cm 10/10 100  
Consultar



### 9134 **Roger**

Manopla de cocina en poliéster. Acabado en color blanco con bordes y cinta para colgar en color. Cara lisa ideal para sublimación.

19 x 30,5 cm 1/50 200  
E(1), N(8), R





# PARTY & EVENTS

# LEVY

# NATURAL

# HAT



29



02

## 7014 **Levy**

Sombrero de fibra sintética de gran calidad con banda confort interior.



25



100



Consultar



01

03

31

60

05

226

02

40

7060 **Dusk**

Sombrero de poliéster.



25



200



F(1)



01

07

02

7015 **Beloc**

Sombrero en material sintético con banda confort interior



25



100



Consultar



01

07

7018 **Jones**

Sombrero de ala plana en material sintético con banda confort interior.



25



100

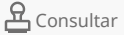

Consultar



CUSTOMIZABLE  
BANDS

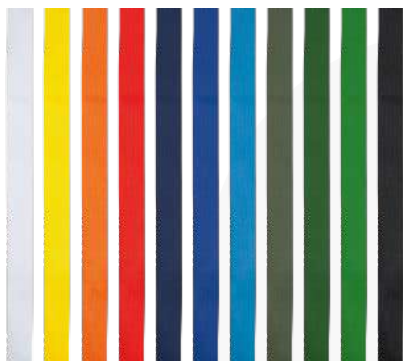

01

03

31

60

55

05

242

13

56

226

02

7013 **Comet**

Cinta para sombrero de non-woven.



67 x 2,7 cm



10/500



5000



Consultar



# STRAW HATS

## 7062 Halley

Sombrero de paja natural con banda confort interior.

 250

 Consultar



## 7061 Sun

Sombrero de paja natural con banda confort interior.

 250

 Consultar



29



13

## 7063 Galaxy

Sombrero de paja natural con banda confort interior.

 250

 Consultar



NEW.

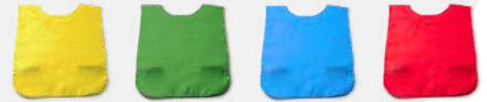

03

226

05

60

9322 **Dalic**

Peto deportivo de poliéster 190T. Banda elástica en los laterales con cierre de velcro.

63 x 52 cm

1/25

300

F(1)

NEW  
DALIE

9003 **Festero**

Pañoleta de diseño triangular en suave poliéster de 60 g/m<sup>2</sup>. Color blanco ideal para marcaje en sublimación. Talla única.

100 x 70 x 70 cm

100

1000

E(1), N(8), R



3101 **Carnival**

Silbato de diseño clásico con cinta para el cuello.

1,9 x 2,4 x 5 cm

10/250

1000

C(1)



**NEW.**  
COLOR



### 3106 Jamboree

Set de bastoms / aplaudidores inflables y reutilizables realizados en LDPE. Incluye válvula de inflado.

61 x Ø10 cm 1/25 500  
G(1)

**NEW.**



### 3109 Suport

Set de bastoms / aplaudidores inflables y reutilizables realizados en LDPE. Estampado de banderas. Incluye válvula de inflado.

61 x Ø10 cm 1/25 500  
G(1)

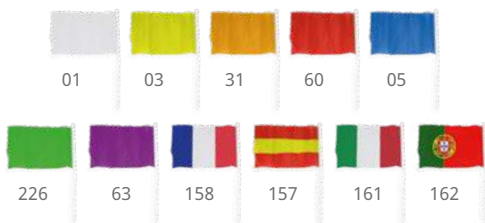

### 3103 Celeb

Banderín de animación realizado en poliéster 170T. Disponible en colores lisos y banderas.

21 x 14 cm 10 2000  
D(6)



### 3105 Revel

Aplaudidor con diseño bicolor en forma de mano.

18,5 x 8,5 cm 1/100 200  
E(4)



NEW.

3112 **Milos**

Abanico con varillas de madera y tela en RPET.  
Presentación en caja eco.

42,5 x 23 x 3 cm 1/25  250

 D(1), E(2), L1



# NUEVOS ABANICOS



NEW.

3113 **Zante**

Abanico con varillas de madera y tela en algodón.  
Presentación en caja eco.

42,5 x 23 x 4 cm 1/25  200

 D(1), E(2), L1



### 3110 **Albero**

Abanico con varillas de plástico y tela en poliéster.  
Presentación en caja blanca.

43 x 23 cm 1/25 250

D(1), E(2)

**NEW.**  
COLOR



### 3111 **Calesa**

Abanico con varillas de madera y tela en poliéster.  
Presentación en caja blanca.

42,5 x 23 cm 1/25 250

D(1), E(2), L1



**NEW.**



### 3114 **Keros**

Abanico con varillas de madera y tela con estampado multicolor. Presentación en caja blanca.

42,5 x 23 x 3 cm 1/25 250

D(1), E(2), L1



3102 **Fete**

Pulsera ajustable de poliéster.

34,5 x 1,2 cm 50/500 2000

D(1), R



3098 **Orbit**

Pulsera de algodón natural con cierre de seguridad (no retornable) en bambú.

35 x 1,5 cm 100 2000

D(1)

FOR ALL  
EVENTS



3094 **Drilo**

Pulsera para eventos de fibra sintética con numeración individual. Presentación en plancha de 20 unidades.

25,4 x 1,9 cm 1000 20000

A(1)

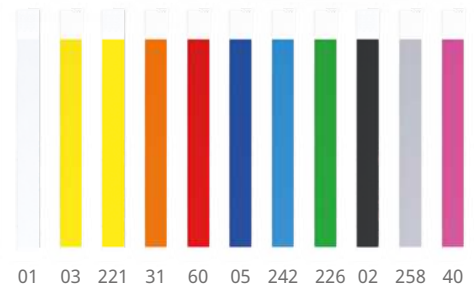

3100 **Party**

Pulsera para eventos de fibra sintética con numeración individual. Presentación en plancha de 10 unidades.

25,8 x 2,7 cm 10/1000 20000

A(1)

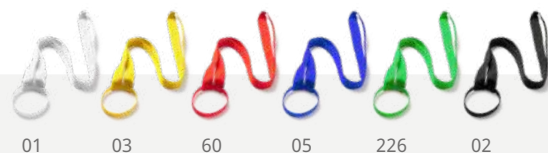

**NEW.**

01      03      60      05      226      02

**7047 Aldaz**

Lanyard portavasos con banda de silicona adaptable.

45 x Ø6 cm      10      1000

F(1), N(8), R

500ml

**4210 Pontal**

Vaso reutilizable realizado en resistente PP flexible. Capacidad 500 ml.

11,6 x Ø9,2 cm      25      500

C(1)

**NEW.****NEW.**

01      60      05      226      02

**7046 Dalvik**

Lanyard de silicona con soporte para móvil y tarjetas. Con sistema de ajuste y mosquetón.

58 x 7 cm      10      300

G(1)



**NEW.**

SUBLIMACIÓN .....



01

02

7043 **Sumba**

Lanyard con accesorio retráctil extensible. Incluye mosquetón.

55 x 1 x 3,2 cm 10 500

D(1), G(1), N(8), R, V



01

60

05

02

**NEW.**



4209 **Doki**

Llavero rollerclip con mosquetón y anilla retráctil extensible.

12,5 x 1,5 x 3,2 cm 1/100 800

C(4), V



SUBLIMACIÓN



### 7054 **Guest**

Lanyard de poliéster con mosquetón, hebilla y cierre de seguridad.

2 x 55 cm

10/100 600

F(1), N(8), R

# ELIGE TU LANYARD



29

### 7044 **Nela**

Lanyard de algodón con mosquetón, hebilla y cierre de seguridad.

52 x 2 cm

10

500

F(1), N(8)



100% COTTON

**NEW.**





7052 **Roomer**

Lanyard de algodón con mosquetón.

2 x 50 cm

10/100 800

F(1), N(8)

100% COTTON

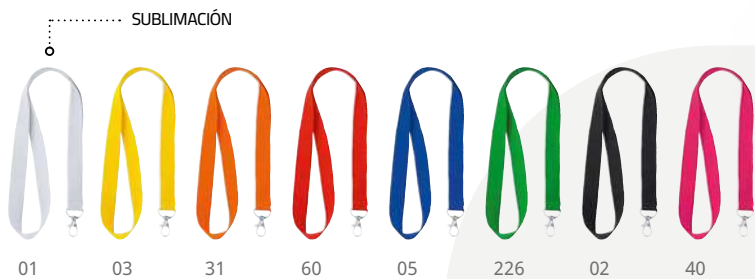

01 03 31 60 05 226 02 40



7055 **Ecohost**

Lanyard de RPET con mosquetón.

2 x 50 cm

10/100 800

F(1), N(8), R

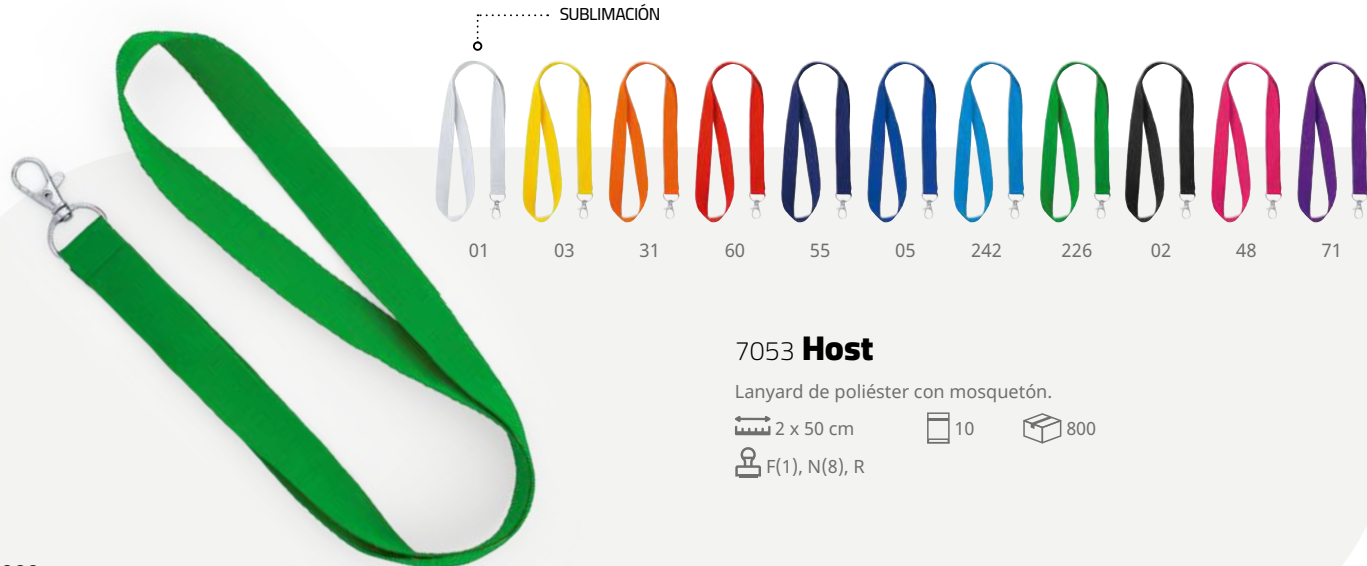

01 03 31 60 55 05 242 226 02 48 71

7053 **Host**

Lanyard de poliéster con mosquetón.

2 x 50 cm

10 800

F(1), N(8), R

**NEW.****7045 Pomel**

Lanyard con mosquetón e identificador de PVC a juego.

58 x 11 cm

10

1000

B(1), F(1)

**NEW.****7068 Tabor**

Identificador transparente de PVC de diseño vertical.

12,1 x 8,4 cm

200

2000

C(1)

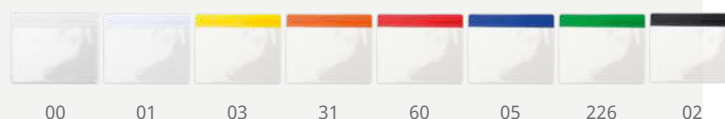
**7070 Bash**

Identificador transparente de PVC.

11 x 9,5 cm

10/100

1000

C(1)

**NEW.****7069 Ganda**

Identificador con frontal de aluminio. Doble sistema de fijación.

6,8 x 3,4 cm

1/100

1000

C(4), L1



# ARTÍCULOS PERSONALIZADOS BAJO PEDIDO



· IMPRESIÓN EN SUBLIMACIÓN INCLUIDA  
· PEDIDO MÍNIMO 250 PCS.



## 4124 **Kendal**

Llavero con tiras de poliéster especial para sublimación.

 12 x 2 cm



## 7071 **Sinatra**

Lanyard de poliéster doble con mosquetón especial para sublimación.

 100 x 2 cm



## 7049 **Elvis**

Lanyard de poliéster con mosquetón especial para sublimación.

 50 x 2 cm



# SUBLIMATION FULL COLOR INCLUDED



## 3097 **Areta**

Pulsera ajustable de poliéster especial para sublimación.

 30 x 1,5 cm



CIERRE DE  
SEGURIDAD

## 3095 **Spring**

Pulsera ajustable de poliéster especial para sublimación.

 30 x 1,5 cm



## 3096 **Paradis**

Pulsera sin cierre de poliéster especial para sublimación .

 30 x 1,5 cm

**SUMMER**

# NEW BARI

GAFAS DE SOL TRANSLÚCIDAS



RECYCLED  
PET

## 8105 Bari

Gafas de sol de diseño clásico con acabado translúcido.  
Protección UV400.

 14 x 4,5 cm

 1/10

 300

 D(2)

**NEW.**







02

01



### 8104 **Eden**

Gafas de sol de atractivo diseño con montura en acabado brillante y patillas en bambú natural. Lentes con protección UV400.

14,5 x 5 cm

1/10

300

D(2), L1



245

248

257



237

999

### 8102 **Dax**

Gafas de sol de diseño clásico en acabado efecto madera con protección UV400.

14,5 x 4,9 cm

1/10

300

D(2)



SUBLIMACIÓN



01

03

31

60

05

226

02

40

### 8110 **Cloud**

Funda para gafas con cordones autocierre. Poliéster de tacto suave.

9 x 18 cm

50

1000

D(1), N(8), R





8100 **Brisa**

Gafas de sol de diseño clásico en acabado brillo con protección UV400.

14,5 x 4,9 cm 1/10 300 D(2)



8103 **Ariel**

Gafas de sol con montura en acabado mate y lentes con protección UV400.

14,5 x 5 cm 1/10 300 D(2)



8101 **Ciro**

Gafas de sol de diseño clásico en acabado negro mate y lentes de espejo. Protección UV400.

14,5 x 4,9 cm 1/10 300 D(2)



7096 **Denia**

Pareo 100% de algodón 180 g/m<sup>2</sup>.

180 x 90 cm  1  50

 F(1), N(8), O, P

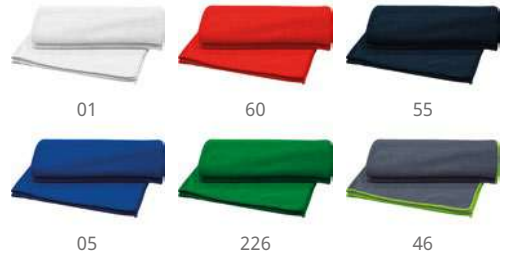

7100 **Orly**

Toalla de playa en diseño bicolor con práctico elástico para su fácil plegado. 80% poliéster y 20% poliamida de 280 g/m<sup>2</sup>.

S  38 x 68 cm  10  100  
 M  60 x 145 cm  10  50  
 F(1), N(8), O, P, R



2 TAMAÑOS





6999 **Bobin**

Gorro estilo bob 100% algodón.

32 x Ø60 cm

50

200

F(1), N(8), O, P



8150 **Kalay**

Chancas de playa con suela de comfortable PE y tiras en PVC. Tallas 36-38, 42-44.

26 x 1,3 x 9,5 cm

10

60

D(1), E(1)

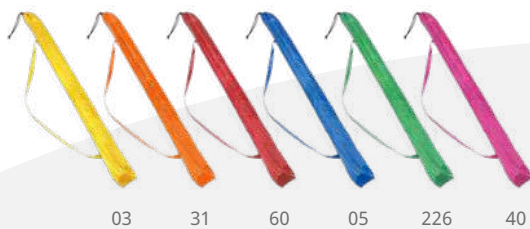

1006 **Skye**

Sombrilla de playa de 8 paneles realizada en nylon. Protección UV interior y faldones ribeteados. Incluye funda de transporte con cinta para el hombro.

100 x Ø155 cm

1

12

H(1), N(8)



PROTECCIÓN UV



1022 **Calon**

Frisbee de diseño clásico en resistente PP.

1,8 x Ø23 cm 1/100 200  
D(1)

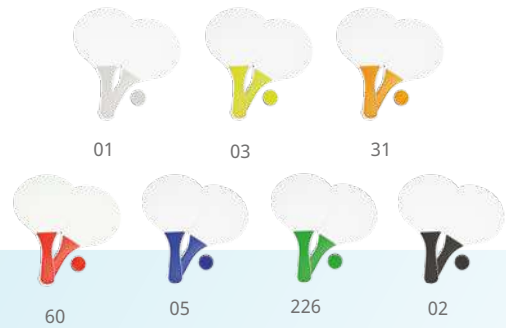

1003 **Feroe**

Palas de playa realizadas en madera con mango reforzado a color. Incluye pelota a juego. Presentadas en bolsa tipo red.

18,5 x 33 x 0,6 cm 1 30  
F(1)



2150 **Saona**

Balón inflable de PVC. Desinflado: 37 cm. Inflado: 28 cm.

Ø28 cm 10/100 200  
F(1), G(1)



6L

4121 **Kinto**

Cubo metálico con asa. Incluye abridor de aluminio.  
Capacidad 6L.

18,5 x Ø23 cm  1  20

 G(1)

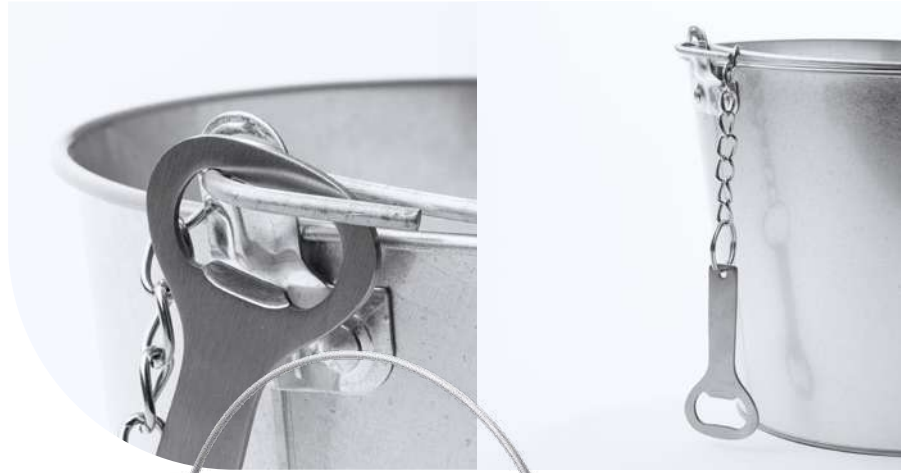

NEW.

NEW LAMBIC



01

60

05

226

02

6L

4208 **Lambic**

Cubo metálico de colores. Incluye abridor de aluminio.  
Capacidad 6L.

18,5 x Ø23 cm  1  20

 G(1)

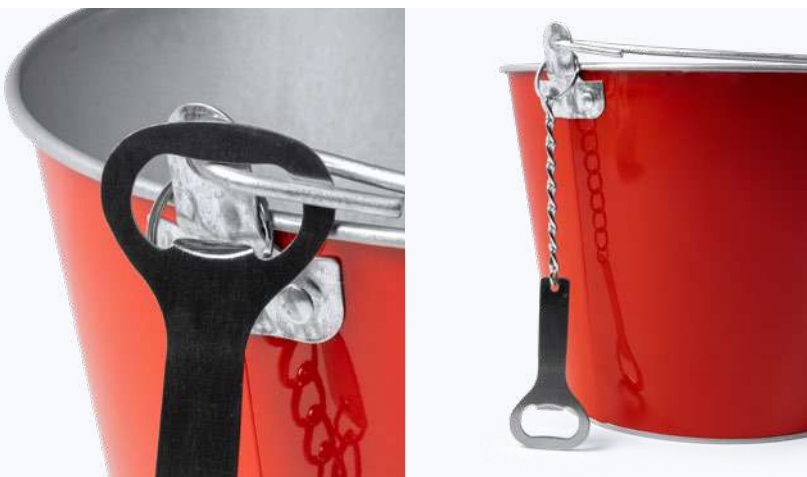





TÁCTIL



### 8202 Eider

Portatodo impermeable de PVC apto para pantallas táctiles.

9,5 x 23 cm

1/50

500

E(1)

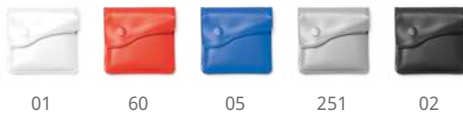

### 1023 Cenix

Cenicero de bolsillo con interior en aluminio ignífugo. Cierre de solapa con botón.

8 x 1,1 x 8 cm

1/50

500

C(1)



### 8205 Lanka

Portatodo impermeable grande de PVC apto para pantallas táctiles.

12,5 x 23 cm

1/50

300

E(1)



TÁCTIL



# BOLSAS ESTANCAS



01

60

05

2,5L

## 7531 Aleta

Bolsa impermeable de resistente ripstop, con práctica ventana con bolsillo para el móvil. Sistema de cierre estanco con clic y mosquetón de transporte. 2,5 L de capacidad útil. 3 L de capacidad total.

29,5 x Ø11,5 cm 1/10 200

F(1)



01

60

05

5L

## 7532 Monje

Bolsa impermeable de resistente ripstop. Sistema de cierre estanco con clic y mosquetón de transporte. 5 L de capacidad útil. 8,5 L de capacidad total.

35 x Ø18 cm 1/10 100

F(1)



60

05

02

10L

## 7533 Manati

Bolsa impermeable de resistente ripstop. Sistema de cierre estanco con clic. Mosquetón y cinta bandolera ajustable para transporte. 10 L de capacidad útil. 15 L de capacidad total.

45,5 x Ø20,5 cm 1/10 100

F(1)



### 7161 Venice

Bolsa nevera de yute laminado. Interior isotérmico de aluminio con cierre de velcro. Bolsillo frontal y asas en algodón natural.



43 x 20 x 34 cm  10  40  
 F(1), N(8)

**NEW.**



### 7197 Lubin

Bolsa nevera plegable de poliéster 190T. Interior isotérmico de aluminio con cierre de cremallera. Asas reforzadas. Fácil plegado con cremallera.

45 x 36 x 9 cm  1/20  100  
 G(1)



### 7603 Tibu

Nevera con interior isotérmico de aluminio para 6 latas. Exterior en resistente PVC. Asa de transporte a juego y cierre de cremallera.

21 x 15 x 15 cm  1/25  200  
 F(1), N(8)



**NEW.**



10

05

47

### 7088 Sakra

Mochila nevera de poliéster 210D Ripstop. Bolsillo principal y frontal con interior isotérmico. Compartimento de cuerda elástica frontal y bolsillos laterales de rejilla. Capacidad 20L. Espalda y tiras acolchadas.

26 x 40 x 19 cm 1 10

G(1), N(8)



**NEW.**



55

02



### 7089 Lombok

Mochila nevera realizada en RPET. Bolsillo principal con interior isotérmico y bolsillo en la solapa. Bolsillos laterales de rejilla. Capacidad 19L. Espalda y tiras acolchadas.

30 x 43 x 15 cm 1 20

G(1), N(8)



05

226

02

40

01

03

31

60

### 7604 Graja

Mochila nevera de cordones con interior isotérmico de aluminio. Exterior de poliéster 210D.

32 x 42 cm 1/10 200

F(1), N(8)



# LEISURE & SPORT



60

05

02

## 7095 **Vulcan**

Set de bastones plegables en aluminio con sistema de amortiguación. Agarre ergonómico y cinta de seguridad ajustable. Incluye accesorio para nieve. Superficie de contacto con el suelo reforzada. Presentación en práctica bolsa de transporte con cinta para hombro.

140 x Ø cm 1 20  
G(1), L2, N(8)

# 3 ACCESORIOS







### 7093 **Regina**

Cuerda de saltar en algodón con mangos de madera lisos. Presentación en bolsa de algodón.

280 x Ø2,70 cm 1 50

D(1), L2, N(8)



# FITNESS MOOD



### 7094 **Rocky**

Cuerda de saltar técnica regulable. Incluye funda para guardar con cordones.

300 x 14,5 cm 1 100

G(1), N(8)



### 7097 Emon

Set de bandas elásticas para fitness con diferentes niveles de resistencia. Funda de poliéster.

9 x 21 cm

1/20

100

F(1), N(8)



# ALTA INTENSIDAD

BAJO

MEDIO

ALTO

# 3 NIVELES



# YOGA LOVED

BOLSA DE  
TRANSPORTE



60

05

02

## 7102 Chakra

Esterilla de yoga con práctica funda de transporte. Ligera, resistente y adherente al suelo.

 180 x 60 cm

 1

 20

 G(1), K(1)





# NEW AURA

NEW.



NATURAL  
CORK

## 7092 **Aura**

Esterilla de yoga de corcho natural con base antideslizante y cinta para transporte.

60 x 180 cm



1



10

G(1), N(8), L2





**NEW.**



03

60

05

226

9322 **Dalic**

Peto deportivo de poliéster 190T. Banda elástica en los laterales con cierre de velcro.

63 x 52 cm

1/25

300

F(1)

# ACCESORIOS DE DEPORTE

**NEW.**



01

60

05

02

2151 **Tuchel**

Balón de fútbol de tamaño 5. Realizado en polipiel de acabado bicolor.

Ø21,50 cm

1

40



G(1)



NEW.

**3093 Yuma**

Pulsera reflectante auto ajustable de PVC.

 30 x 2,9 cm
  1/50
  1000

 D(1)

## REFLECTIVE BAND



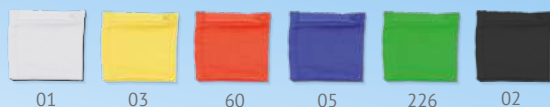

BOLSILLO



01 03 60 05 226 02

**7105 Speed**

Muñequera elástica realizada en suave microfibra. Bolsillo con cierre de cremallera incorporado.

 10 x 9 cm
  1/100
  1000

 E(1), N(8), R

22102 7802 22302 02221 02221

**7118 Marathon**

Cinturón deportivo multiusos de tejido elástico impermeable. Cremallera reflectante y salida para cables. 100% poliéster. Etiqueta removible.

 23 x 5,5 cm
  10/10
  200

 N(8)



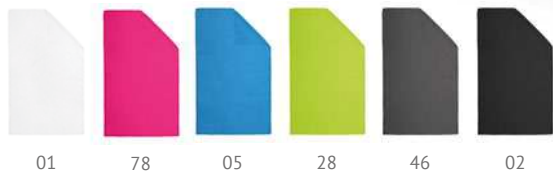

### 7119 **Cork**

Toalla multi-deporte de microfibra con práctica banda elástica para su fácil plegado. Secado rápido. 90% poliéster y 10% poliamida de 190 g/m<sup>2</sup>. Etiqueta removible.

70 x 120 cm 10/10 100

F(1), N(8), O, P, R

FUNDA TRANSPORTE



SUBLIMACIÓN



### 7103 **Bay**

Toalla absorbente realizada en microfibra de 345 g/m<sup>2</sup>. Funda reutilizable de PVC incluida.

45 x 30 cm 1 100

F(1), N(8), O, P, R



### 7101 **Calpe**

Toalla refrescante de microfibra. Presentación en práctico estuche con mosquetón.

13 x 5,4 x 3 cm 1/50 200

G(1), N(8)



FUNDA TRANSPORTE



### 7057 **Kelsey**

Toalla absorbente realizada en microfibra 185 g/m<sup>2</sup>. Incluye funda de transporte con cierre ajustable.

100 x 50 cm 1 100

G(1), N(8), O, P, R

# CROSSFITTER



## 9001 Crossfitter

Cinta deportiva en tejido técnico transpirable. 100% poliéster de 140 g/m<sup>2</sup>.

22,5 x 8 cm 10/10 300

F(1), N(8)

# OLYMPIA

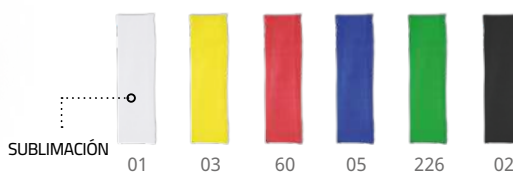

## 7104 Olympia

Cinta elástica deportiva para la cabeza realizada en suave microfibra.

23,5 x 6 cm 1/100 800

G(1), N(8), R

# WIZER



SUBLIMACIÓN



## 7048 Wizer

Visera deportiva de poliéster. Con cierre de velcro y laterales acolchados.

F(1), N(8), O, P, R 25 200



NEW **KARIN**

NEW.



01

60

05

55

02

7026 **Karin**

Gorra deportiva ventilada de 6 paneles 100% microfibra.  
Cierre de hebilla ajustable y orificios de ventilación.  
Etiqueta removible.

 25  200

 F(1), N(8), O, P, R

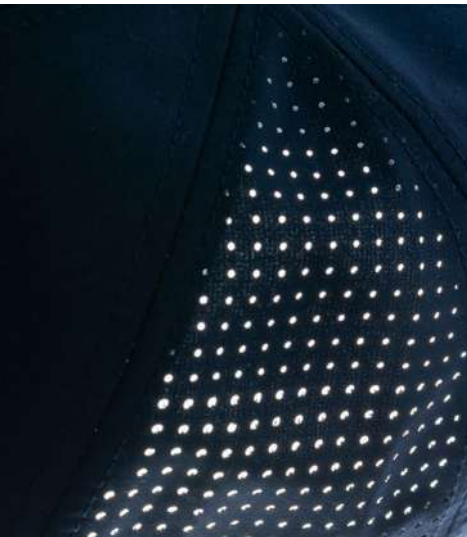

01

221

234

05

02

7020 **Mercury**

Gorra técnica de 3 paneles. Tejido ligero y transpirable con  
cierre de velcro ajustable. 90% poliéster y 10% elastano de  
40 g/m<sup>2</sup>. Etiqueta removible

 25  200

 F(1), N(8), O, P, R



**NEW.**

221



223

**7033 Balder**

Gorra de 5 paneles 100% poliéster con detalles reflectantes. Cierre de velcro ajustable y orificios de ventilación. Etiqueta removible.

☐ 25    📦 200  
 👤 F(1), N(8), O, P



01



55

**7023 Iberis**

Gorra de 5 paneles 100% algodón peinado con diseño de bandera nacional. Cierre ajustable de velcro y orificios de ventilación. Etiqueta removible.

☐ 25    📦 200  
 👤 F(1), N(8), O, P

**NEW.**

# 100% RECYCLED PET



## 7000 **Basica**

Gorra de 5 paneles con orificios de ventilación bordados y cierre de velcro ajustable.

25 300  
Consultar



## 7050 **Calisto**

Gorra de RPET con 5 paneles. Cierre de velcro ajustable.

25/75 300  
F(1), N(8), O, P, R



NEW.

# NEW FREYA



## 7030 Freya

Gorra de 5 paneles 100% algodón. Cierre ajustable de velcro y orificios de ventilación. Etiqueta removible.

Ø59,00 cm

30

300

F(1), N(8), O, P

# 100% COTTON





**NEW.**



7024 **Tarvos**

Gorra de 5 paneles 100% algodón orgánico. Cierre de velcro ajustable y orificios de ventilación. Etiqueta removible.

25 200  
F(1), N(8), O, P



01



05



226



02



7009 **Fides**

Gorra de 5 paneles 100% algodón reciclado. Cierre de velcro ajustable y orificios de ventilación. Etiqueta removible.

25 200  
F(1), N(8), O, P

**NEW.**



**Kids**



01

**Kids**



03

**Kids**



60



55



05

**Kids**



226



02

7041 **Uranus**

Gorra de 5 paneles en 100% algodón de 170 g/m<sup>2</sup>. Cierre ajustable de velcro y orificios de ventilación bordados. Etiqueta removible.

25 300  
F(1), N(8), O, P



### 7012 Terra

Gorra de estilo casual de 6 paneles. Interior de la visera en acabado a contraste. Ojales y cierre ajustable metálicos. 100% algodón de 260 g/m<sup>2</sup>. Etiqueta removible.

25 200  
F(1), N(8), O, P



### 7008 Panel

Gorra de 6 paneles en 100% algodón con sándwich a contraste. 6 orificios de ventilación y cierre de velcro ajustable. Etiqueta removible.

25 200  
F(1), N(8), O, P



### 7019 Eris

Gorra de 5 paneles con sándwich a contraste y cuatro orificios de ventilación bordados. Cierre de velcro ajustable y etiqueta removible. 100% algodón de 170 g/m<sup>2</sup>.

25 200  
F(1), N(8), O, P

# PERSONAL CARE



NATURAL  
CORK

NEW.

1126 **Podox**

Set de manicura con funda de corcho y cierre de corchete. Incluye tijeras, pinzas, cortaúñas, lima y quita cutículas de acero inoxidable.

11 x 6 x 2 cm 1/50 200

E(1), L1, N(8)



# PEDICURE ACCESSORIES



NEW.

1125 **Velvet**

Set de manicura en bolsa de algodón con cierre de cordón ajustable. Incluye lima y cortaúñas.

12 x 7,8 cm 1/50 400

F(1), L1, N(8)





**NEW.**



**NEW.**

# BAMBOO



BAMBOO



## 1215 **Rizo**

Peine de bambú natural con mango. Presentación en caja de diseño eco.

 3,5 x 18,4 x 0,6 cm

 1/100  500

 C(4), L1



BAMBOO



## 1214 **Kurly**

Peine de bambú natural. Presentación en caja de diseño eco.

 13,8 x 3 x 0,6 cm  1/100  500

 C(4), L1





NATURAL  
CORK1231 **Belle**

Espejo plegable de bolsillo realizado en corcho natural y metal cromado, compuesto por dos espejos, uno normal y otro de aumento. Presentación en caja diseño eco.

2 x Ø6,10 cm 1/50 200

C(4), L1, W



2X

1220 **Glaze**

Práctico espejo plegable de bolsillo con carcasa de PP translúcido.

0,5 x Ø6 cm 1/50 500

C(4), W

1223 **Liner**

Espejo doble, uno normal y otro de aumento, con tapas de suave PU y cierre magnético.

0,9 x Ø7 cm 1/50 300

C(4), L1, W

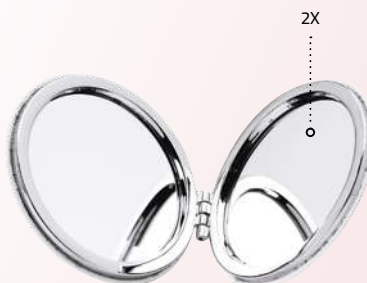

2X

1221 **Blunt**

Práctico cepillo plegable de bolsillo con espejo, realizado en PP con diseño sólido.

2,3 x Ø6,60 cm 1/50 200

C(4)





251



281



260

**NEW.**

**1216 Dumai**

Práctico cepillo anti enredo con acabado brillante.

6,7 x 4,5 x 9 cm 1/50 200

D(1)

# BEAUTIFUL PURSES

**NEW.**



251



281



260

**7570 Mauve**

Monedero de PU en acabado brillante con cremallera y tirador a juego.

12 x 8,5 x 0,5 cm 1/10 1000

D(1)



251



49



260

## 1225 Beiso

Bálsamo labial presentado en estuche de diseño tipo esfera, con acabado cromado. Protección SPF15.

Ø3,80 cm

1/50

500

C(1)



# PROTECTOR LABIAL



## 1230 Lapp

Bálsamo labial con clásico estuche en forma de barra, realizado en fibra de trigo. Protección SPF15.

7 x Ø1,90 cm

1/25

500

C(1)



01

03

31

60

40

05

226

## 1124 Lissen

Bálsamo labial con clásico estuche en forma de barra en acabado translúcido. Protección SPF15.

7 x Ø1,90 cm

1/25

500

C(1)



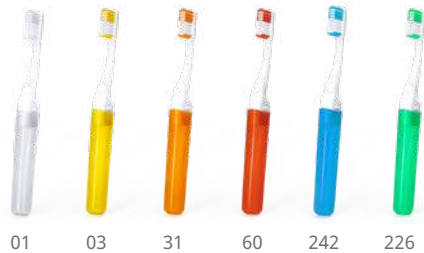

9924 **Pole**

Cepillo de dientes plegable en PP tamaño viaje.  
Cerdas de dureza suave a juego.

17,5 x 2,3 x 1,5 cm

1/50 500

C(1), W

CHOOSE  
YOUR  
COLOR



9944 **Clive**

Cepillo de dientes con divertido cuerpo de colores y acabado suave, con ventosas en la base para su sujeción.

14,5 x 1,5 x 2,7 cm

1/50 500

F(1), L1



03 31 60 05 226





01

60

05

226

9945 **Kora**

Cepillo de dientes con cuerpo de PLA. Cerdas blancas de dureza suave. Presentación en caja eco.

18,4 x 1,6 x 1,4 cm

1/100 600

C(1)



BAMBOO

9923 **Fresh**

Cepillo dental con cuerpo realizado en bambú y cerdas blancas de dureza suave. Libre de aditivos BPA y 100% biodegradable. Presentación en caja diseño de cartón kraft.

17,5 x 1,6 x 1,3 cm

1/50

400

C(4), L1

# BIO DEGRA DABLE



# DIVERTIDOS CEPILLOS DE DIENTES



03

60

05

226

9946 **Mesler**

Set de cepillo de dientes y reloj de arena. Cepillo de dientes con divertido cuerpo de colores y acabado suave, con ventosas en la base. Reloj de arena de 2 minutos de duración. Presentación en estuche individual con cierre hermético.

19,5 x 8,5 x 2,5 cm

1/10

200

F(1), L1





9919 **Nobel**

Toallita higienizante hidroalcohólica de un solo uso y compostable. 70% de alcohol. Embolsado individual termosellado.

➦ 5,7 x 8 cm    📦 1/100    📦 3000  
 🧻 A(1)



50ml

9907 **Gilman**

Gel higienizante de manos. Práctica botella de 50 ml. 70% alcohol.

➦ 4,5 x 8,5 x 2,9 cm    📦 50    📦 200  
 🧻 C(1)

# SANITIZING GEL



01    60    226    05    02

10ml

9908 **Varmus**

Gel higienizante de manos con 70% de alcohol. Práctico recipiente de 10 ml translúcido y pulverizador tipo spray. Capucha con clip disponible en varios colores.

➦ 12,6 x Ø1,60 cm    📦 1/50    📦 500  
 🧻 B(4)



30ml

9906 **Bishop**

Gel higienizante de manos con 70% de alcohol. Práctico recipiente de 30 ml con mosquetón.

➦ 3,5 x 10 x 2,2 cm    📦 1/50    📦 200  
 🧻 C(1)



30ml

9934 **Genzel**

Gel higienizante de manos de 30 ml con pulverizador tipo spray.

➦ 10,1 x Ø2,70 cm    📦 1/100    📦 200  
 🧻 C(1), W

# ORGANIZERS



## 1227 Medy

Práctico pastillero de PP con 2 compartimentos y accesorio cortador.

9,5 x 1,6 x 4,8 cm 1/100 400

C(4), W



01 60 05 226

## 1226 Citos

Pastillero de PP con tres compartimentos y diseño en acabado translúcido.

6 x 1,3 x 3,9 cm 1/100 1000

C(4), W



+ antibacterial  
ISO 22196

## 1222 Drop

Pastillero de tres compartimentos, realizado en PP con tratamiento anti-bacterias.

6 x 1,3 x 3,9 cm 1/100 1000

C(4), W

# STRESS BALLS



NEW.



60 05

## 1232 Dona

Gota anti estrés realizada en PU de color liso.

8 x 0,5 x Ø6 cm 1/20 400

E(1)



01 03 60 05 226 02

## 1228 Seyku

Pelota anti-estrés realizada en PU de color liso.

Ø6,20 cm 1/20 400

E(1)



NEW.  
COLOR



60 01

## 1229 Biku

Corazón anti estrés realizado en PU de color liso.

7 x 7 x 4 cm 1/20 400

E(1)





55

258

02

### 8201 Ansar

Almohadilla inflable de viaje con suave tacto antelina.

33 x 9 x 25 cm 1/20 200

F(1)



### 8200 Branta

Máscara de viaje realizada en suave microfibra. Doble elástico de ajuste.

18,5 x 9 cm 1/100 1000

D(1), N(8)



01

FUNDA INCLUIDA



02



### 8151 Yllier

Zapatillas unisex realizadas en cómodo algodón/poliéster con interior acolchado. Práctica funda de non-woven incluida. Talla única 36-43.

11,5 x 29 x 1,7 cm 1/10 200

E(1), N(8)

HORA DE RELAJARSE

NEW.

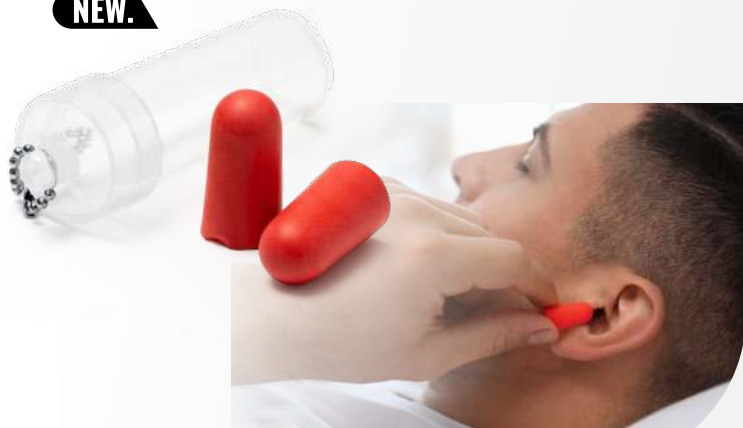

03

60

40

05

226

### 8199 Noys

Tapones para oídos de EVA. Presentación en estuche con cadena de transporte.

6,4 x Ø2,20 cm 1/200 1000

C(1)



02 55 05 60 226

### 7182 Oblak

Zapatillero realizado en poliéster 600D. Incluye práctica asa de transporte.

35 x 15 x 16 cm 1/25 100

F(1), N(8), O

**NEW.**



### 9935 Arnold

Neceser de viaje transparente realizado en PVC con cierre hermético. Incluye surtido de prácticos botes ideales para gel, champú y perfume.

19 x 19 cm 1 100

F(1)

**NEW.**



### 2991 Covas

Alarma personal. Se activa al separar el conector enganchado con el llavero. Presentación en caja diseño.

3,9 x 6,1 x 1,9 cm 1/50 300

D(4)



01 03 31 60 40 05 226

### 7511 Caribu

Neceser de PVC transparente con cierre hermético.

17 x 13 x 5 cm 1/50 400

F(1)



### 9939 Strickland

Funda neceser de PVC multiusos. Cuerpo transparente con cierre a color. Ideal para guardar todo tipo de mascarillas.

20 x 12,5 x 0,25 cm 20 1000

E(1)



**NEW.**



**NEW.**



7497 **Naro**

Neceser multiusos 100% algodón Fairtrade de 180 g/m<sup>2</sup>. Bolsillo principal con cremallera y tirador a juego.

21 x 13 x 8 cm 10 100  
 F(4), N(8), O, P



7498 **Zigari**

Neceser multiusos 100% algodón Fairtrade de 180 g/m<sup>2</sup>. Bolsillo principal con cremallera y tirador a juego.

23 x 17 x 6 cm 50 300  
 F(4), N(8), O, P



7537 **Doel**

Neceser multiusos en algodón de 280 g/m<sup>2</sup> con acabado bicolor. Cremallera con tirador de algodón a juego.

22,5 x 17 x 5,5 cm 1/50 300  
 F(1), N(8)







### 7558 Sierra

Neceser multiusos realizado en algodón de 180 g/m<sup>2</sup> y yute. Cremallera con tirador de yute a juego.

21,5 x 16 x 5 cm 10 200  
F(1), N(8)



### 7564 Siena

Neceser realizado en algodón y yute laminado. Cremallera con tirador de yute a juego.

21 x 11 x 6 cm 1/50 200  
F(1), N(8)



# NATURAL JUTE BAGS



### 7563 Vera

Neceser realizado en algodón y yute laminado. Cremallera con tirador de yute a juego.

20 x 15 x 6 cm 1/50 200  
F(1), N(8)



**NEW.**



01

02



05



226



60



RECYCLED  
PET

7547 **Bubo**

Neceser de dos compartimentos con cremalleras y cinta de transporte a juego. Realizado en poliéster reciclado RPET 210D.

21 x 13 x 8 cm 1/20 100

F(1), N(8), O

# RECYCLED PET

# CÁÑAMO NATURAL



261



152



02



HEMP

7499 **Prado**

Neceser multiusos realizado en tela de cáñamo 200 g/m<sup>2</sup>. Tirador a juego.

21 x 13 x 8 cm 1/10 100

F(1), N(8)



### 7514 Yubarta

Necesar de poliéster 600D. Cremallera con tirador a juego.

22 x 14 x 6 cm 10 300  
 F(1), N(8), O



### 7565 Sedna

Necesar multiusos de poliéster 600D. Cierre de cremallera con tirador a juego.

22 x 14 x 6 cm 1/20 300  
 F(1), N(8), O



### 7513 Pardela

Necesar de poliéster 600D con cremallera y práctica asa de transporte.

20 x 10 x 8 cm 1/10 200  
 F(1), N(8), O





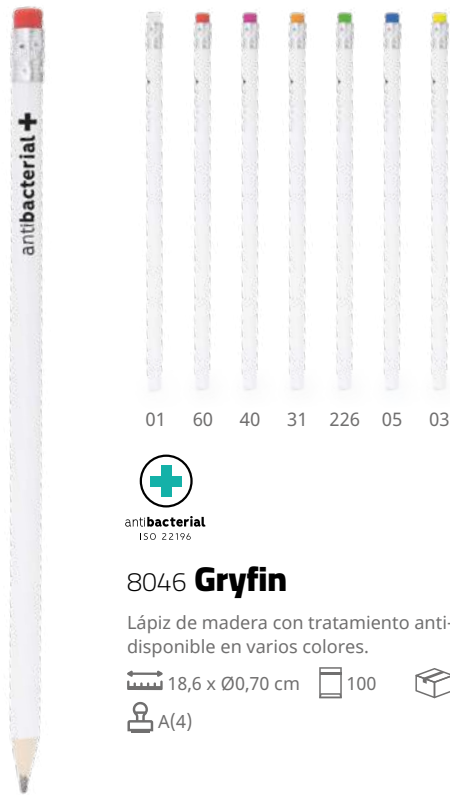

01 60 40 31 226 05 03



antibacterial  
ISO 22196

### 8046 Gryfin

Lápiz de madera con tratamiento anti-bacterias y goma disponible en varios colores.

18,6 x Ø0,70 cm 100 2000

A(4)



01 60 05 02



antibacterial  
ISO 22196



TOUCH  
PEN

### 8022 Farber

Bolígrafo higienizante anti-bacterias multifunción, con pulverizador recargable y puntero táctil. 3 ml de capacidad (líquido no incluido). Tinta azul.

16 x Ø1,50 cm 1/50 1000

B(4)

# ANTIBACTERIAL



ELION8061

WATSON8060



antibacterial  
ISO 22196



### 8060 Watson

Bloc de notas tamaño A5. Cubiertas de PU con tecnología anti-bacteriana. Marcapáginas y banda elástica. 100 hojas. Norma ISO 22196.

14,9 x 21 x 1,4 cm 1/25 50

E(4)



antibacterial  
ISO 22196



### 8061 Elion

Bloc de notas tamaño A6. Cubiertas de PU con tecnología anti-bacteriana. Marcapáginas y banda elástica. 80 hojas. Norma ISO 22196.

9 x 14 x 1,4 cm 1/50 100

E(4)

# + antibacterial

ISO 22196



antibacterial  
ISO 22196

## 8040 Stark



Bolígrafo con cuerpo de ABS anti-bacterias. Tinta azul.  
Norma ISO 22196:2011.

13,8 x Ø1 cm 1/50 1000

A(4)



antibacterial  
ISO 22196



TOUCH  
PEN

## 8015 Hallerbos



Bolígrafo con cuerpo de ABS anti-bacterias, puntero táctil, clip metálico y carga jumbo de tinta azul.  
Norma ISO 22196:2011.

13,9 x Ø1 cm 1/50 1000

A(4)



# ANTIBACTERIAL



03 31 60 05 226 02



antibacterial  
ISO 22196

## 8039 Carrel



Bolígrafo con cuerpo de ABS anti-bacterias y suave agarre de color translúcido. Tinta azul. Norma ISO 22196:2011.

14 x Ø1,30 cm 1/50 1000

A(4)



antibacterial  
ISO 22196

## 8038 Newton



Bolígrafo con cuerpo de ABS anti-bacterias y tinta azul. Norma ISO 22196:2011.

14 x Ø1,30 cm 1/50 1000

A(4)



CHRISTMAS





### 4012 **Berry**

Taza de cerámica en acabado mate con tapa de bambú natural. Capacidad 370 ml. Presentación en caja de cartón kraft.

10,5 x Ø8,20 cm 1 36

F(1), L2

## UN TOQUE DE INSPIRACIÓN NATURAL

CORCHO | CRISTAL | BAMBÚ

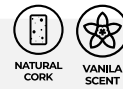

### 1313 **Surna**

Vela aromática en recipiente de cristal y tapón de corcho. Aroma vainilla. Incluye tarjeta de cartón kraft para marcaje. Presentación en caja diseño eco.

7,6 x Ø5,60 cm 1/25 100

(E1)



### 1315 **Vanila**

Vela aromática en vaso de cristal translucido con tapa de bambú. Aroma vainilla. Presentación en caja diseño eco.

8,8 x Ø7,00 cm 1 50

E(1), L2



PIZARRA



VANILLA  
SCENT



### 1307 King

Vela aromática a vainilla con porta-velas pizarra de cerámica. Incluye tiza blanca. Presentación en caja de cartón Kraft.

8,7 x 7,8 x 07 cm



E(1), L1

### 1312 Maka

Vela en soporte de madera con diseños navideños (estrella y árbol). Presentación en caja individual.

8,7 x 2,1 x 8,4 cm 1/100 200

E(1), L1



512



511



01

03

31

60



40

05

226

02



VANILLA  
SCENT

### 1306 Flake

Vela aromática a vainilla en vivos colores presentada a juego con porta-velas metálico. Tapa con ventana transparente.

3 x 06,30 cm



E(1), L1



01 260 60 251 02

**1311 Kimi**

Vela aromática en vaso de cristal de colores y fragancias variadas (café, pino, lavanda, vainilla y fresa). Presentación en caja individual.

6,7 x Ø5,60 cm 1 50  
F(1), L1

# HAZ BRILLAR TU MARCA

## PREMIUM COLOURS



251

260

350 ml

**4024 Zala**

Taza de cerámica de 350 ml con diseño en acabado brillo. Especial para grabado láser. Presentación en caja blanca.

9,6 x Ø8,20 cm 1 36  
F(4), L2





1298 **Tinsel**

Árbol navideño realizado en madera con mensaje. Base desmontable.

11,5 x 17,7 x 3,1 cm

1/100 400

D(4), L1



512



511



510



514

1305 **Jingle**

Adorno navideño de madera disponible en cuatro diseños: estrella, árbol, copo de nieve y bola. Incluye cinta roja para colgar en el árbol de Navidad.

9,5 x 10 cm

1/50 400

C(4), L1



512



511

1299 **Rudolf**

Adorno navideño de pizarra disponible en dos diseños: árbol y estrella. Incluye lazo para colgar en el árbol de navidad.

 8,5 x 10 cm  1/25  100  
 C(1)

BIENVENIDA, **NAVIDAD**

514

512

513

1302 **Abend**

Adorno navideño de fieltro disponible en tres diseños: copo de nieve, árbol de navidad y reno.

 10,1 x 8,3 x 0,3 cm  10/100  500  
 C(1), N(8)

1310 **Carol**

Set de 3 adornos navideños de fieltro: estrella, árbol y reno, para colgar en el árbol de navidad.

 10 x 10 cm  1/100  500  
 C(1)

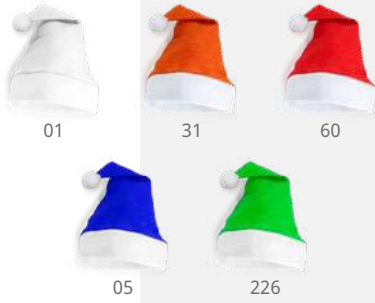

### 1300 **Santa**

Gorro navideño de Papá Noel realizado en suave poliéster. talla única.

43 x 30 cm

10

200

E(1), N(8)



**FEEL  
LIKE  
SANTA  
CLAUS**



### 1301 **Noel**

Calcetín navideño con tira para colgar, realizado en suave poliéster.

34 x 22 cm

10

200

E(1), N(8)



CERAS INCLUIDAS

### 1309 **Nick**

Gorro de Papá Noel infantil para colorear. Tira frontal con dibujos navideños. 4 ceras de colores incluidas.

41 x 27 cm

1/50

300

F(1), N(8)





1304 **Klaus**

Imán navideño con diseño de Papa Noel. Incluye bloc de notas con 45 hojas lisas y lápiz de madera.

20 x 10 cm 1/50 200  
C(2)

CERAS INCLUIDAS



1308 **Reno**

Calcetín con diseño navideño para colorear. Incluye 5 ceras de colores variados. Realizado en non-woven de 80 g/m<sup>2</sup>.

29,5 x 19 cm 1 200  
F(1)



SINAFILAR

515

516

512



1303 **Nuss**

Lápiz con cuerpo de madera en color blanco y goma de borrar con diseños navideños.

19 x 2,7 cm 1/50 500  
B(4)

# MATERIALES

LA MAYORÍA DE LOS MATERIALES QUE UTILIZAMOS EN LA ELABORACIÓN DE NUESTROS PRODUCTOS SON NATURALES O RECICLADOS. GRACIAS A ESTO, ADEMÁS DE CONTRIBUIR CON LA RESPONSABILIDAD DE TENER UN MUNDO MÁS SOSTENIBLE, ESTOS MATERIALES NOS PERMITEN CREAR PRODUCTOS INNOVADORES Y VERSATILES, CON UNA GRAN VARIEDAD DE ACABADOS Y TEXTURAS QUE SE ADAPTAN A TODO TIPO DE ESPACIOS.

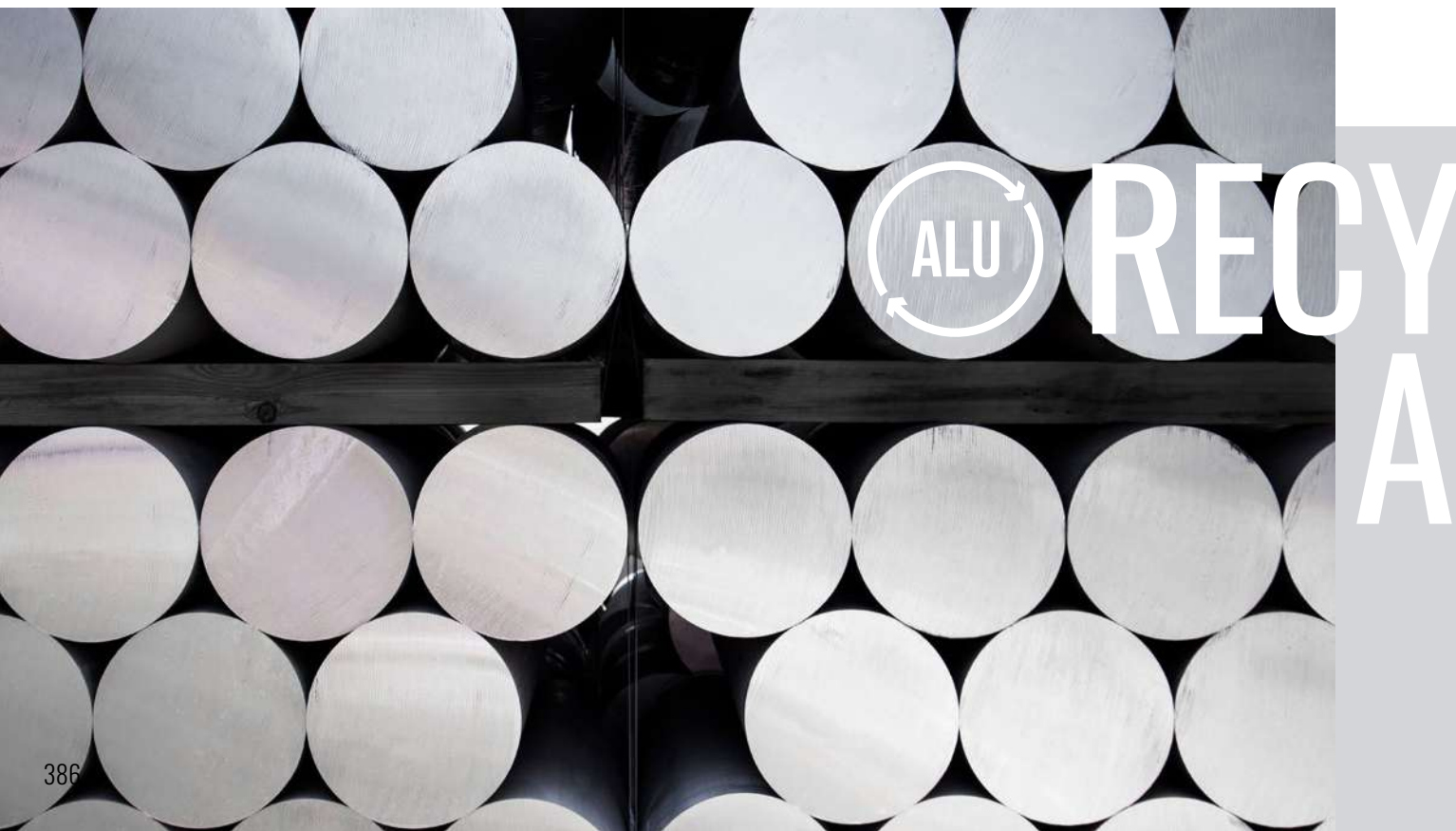

NEW MATERIAL

# RECYCLED LEATHER



El cuero es uno de los materiales naturales más antiguos, duraderos y versátiles que existen. Gracias a su reciclaje, damos un nuevo uso a aquellos residuos de cuero provenientes de la moda o del procesamiento y tratamiento del material en su mayoría pequeños trozos de cuero procesados.



NEW MATERIAL

# RECYCLED ALUMINIUM

El aluminio es un material altamente reciclable. Es fácil de manejar, es ligero, no se rompe, no arde y no se oxida, se puede compactar fácilmente, ocupando poco espacio. Además, puede reciclarse fácilmente al 100% sin perder calidad.







# PLA

También llamado ácido poliláctico, deriva de materias primas naturales y renovables, como el maíz, la remolacha y otros productos ricos en almidón.



# LIMESTONE CEMENT



El cemento de piedra caliza es un conglomerado formado a partir de una mezcla de caliza y arcilla calcinadas y posteriormente molidas. Una vez endurecido al ponerse en contacto con el agua, resulta un material muy consistente y de alta durabilidad.



# NATURAL WOOD



La madera es un material atemporal e inmortal que encaja perfectamente con cualquier estilo decorativo, aportándole un toque distintivo al espacio en el que se coloque. Además de ventajas como la resistencia y durabilidad, incluir madera natural en el hogar reporta una buena cantidad de beneficios, incluida algunos que actúan directamente sobre la salud.



# WHEAT FIBER

La fibra de trigo es un residuo agroindustrial producido durante la extracción de los granos del cereal. Empleado originalmente para alimentación del ganado o como forraje, en los últimos años se ha comenzado a usar como bioplástico derivado de origen vegetal, ayudando a reducir el consumo de plástico.



# NATURAL JUTE



Conocido como la 'fibra dorada', el yute es una de las fibras naturales más usadas para diversas aplicaciones textiles desde antaño. Es una fibra muy fuerte y duradera, con propiedades aislantes y antiestáticas. Es 100% biodegradable y reciclable y, por tanto, inocua para el medio ambiente.

# CORK



El corcho es un material ecológico biodegradable, reciclable y sostenible. Se obtiene de la corteza del alcornoque, que se regenera cada año. Es muy valorado por su ligereza y resistencia. Además es muy buen aislante. Por ejemplo, en forma de esterilla de yoga bloquea el frío que asciende de un suelo frío. A esto se le suma su estética elegante y natural.



# BAMBOO



El bambú es un material natural, ecológico y sostenible. Debido al rápido crecimiento de la planta, es un material muy renovable. Sus ventajas son múltiples y es una buena alternativa al uso de la madera. Es considerado como "Acero Vegetal" por su resistencia a determinados esfuerzos y su buen comportamiento sísmico. Es también un material muy flexible y ligero.

# RECYCLED PET



El PET reciclado o rPET, es el material que más se recicla en todo el mundo, ayudando a reducir los plásticos con lo que se fabrican las botellas PET y ofreciendo una nueva vida a sus residuos. Destaca por ser resistente y actuar eficazmente como protección y barrera ante el vapor de agua y el oxígeno.





# BAMBOO FIBER



La fibra de bambú es una fibra natural que se obtiene de los filamentos de esta planta. Su uso como aditivo en diferentes compuestos da como resultado productos estéticamente atractivos que aportan un toque de naturalidad.



# RECYCLED PAPER

El papel reciclado permite dar una segunda vida a esta fibra de celulosa procedente principalmente de la madera de los árboles. Además, la fabricación de papel a partir de este material reciclado y no de celulosa puede llegar a reducir el costo energético hasta en un 60%.







# RECYCLED ABS

El ABS reciclado o R-ABS es un plástico resistente, de gran durabilidad y que no se corroe fácilmente cuando entra en contacto con materiales abrasivos. Es el resultado que se obtiene tras el proceso de reciclaje del material ABS, ayudando a que no se desperdicie y se deseché después de un solo uso.



# ANTIBACTERIAL

Material tratado con iones de Plata, que evita la proliferación de microorganismos patógenos.



# TRITAN

El Tritan es una nueva generación de resinas de copoliéster reciclables y seguras para la salud. Es un material libre de BPA, BPS y cualquier otro tipo de bisfenol.





# RECYCLED COTTON

El algodón reciclado se obtiene a partir de restos de manufactura de ropa o prendas ya usadas. En su producción se reduce la cantidad de energía, agua y colorantes. Por ello es uno de los tejidos más sostenibles y más respetuosos en todos sus procesos.





# ORGANIC COTTON

El algodón orgánico es un algodón que se produce y certifica según los estándares agrícolas orgánicos. Es suave, cómodo e hipoalergénico. Este tejido tiene la misma calidad que el algodón natural y su cultivo genera un mínimo impacto en el medioambiente.







NEW MATERIAL



# FAIRTRADE COTTON

El algodón de comercio justo certificado garantiza el apoyo de los cultivadores de algodón para que mejoren su calidad de vida y sus comunidades, contribuyendo a proteger a las personas y el medio ambiente.





NEW MATERIAL



# HEMP

El cáñamo es considerado como la fibra textil de origen vegetal más resistente, suave y duradera. Su tela es una de las más antiguas y ecológicas, está hecha a partir de las fibras que se extraen del interior del tallo de la planta del cannabis, que son de origen vegetal y biodegradables. Su gran flexibilidad lo hace ideal para la confección de prendas y accesorios.



NEEDS







REF. PG.

6998	292
6999	337
7000	314, 356
7008	359
7009	358
7012	359
7013	318
7014	317
7015	318
7018	318
7019	359
7020	314, 354
7023	355
7024	358
7026	354
7030	357
7033	355
7041	358
7043	326
7044	327
7045	329
7046	325
7047	325
7048	314, 353
7049	313, 330
7050	314, 356
7052	328
7053	328
7054	327
7055	328
7057	314, 352
7060	318
7061	319
7062	319
7063	319
7068	329
7069	329
7070	329
7071	313, 331
7081	248
7082	248
7083	123
7084	155
7085	152
7086	162
7087	152
7088	160, 343
7089	161, 343
7090	154
7091	153
7092	349
7093	346
7094	346
7095	345
7096	336
7097	347
7098	152
7099	177
7100	336
7101	352
7102	348
7103	314, 352
7104	315, 353
7105	315, 351
7106	125
7107	153, 170
7110	176
7114	157, 302

7115	146
7118	351
7119	314, 352
7120	146
7121	147
7122	182
7123	182
7124	150
7125	188
7126	190
7127	190, 303
7128	187
7137	154
7138	130
7139	124
7145	150
7146	129
7147	184
7148	178
7149	178
7150	156
7151	158
7152	156, 302
7153	149
7154	149, 302
7155	157
7156	169
7157	156
7158	151
7159	168
7160	173
7161	177, 342
7162	170
7163	179
7164	179
7165	153
7166	187
7167	168
7168	168
7169	280
7170	145
7171	128
7172	127
7173	129
7174	151
7175	154
7176	125
7177	126
7178	122
7179	145
7180	155, 191, 301
7181	149
7182	147, 371
7183	148
7184	155
7185	176
7186	119
7187	120
7188	171
7189	171
7190	167
7191	167
7193	169
7194	166
7195	166
7196	173
7197	160, 342
7198	144

7497	138, 372
7498	139, 372
7499	374
7500	124
7501	189
7502	189
7503	188
7504	189
7506	190
7511	143, 371
7513	143, 375
7514	143, 375
7515	130
7516	131
7517	131
7518	131
7519	174
7520	172
7521	173
7522	186, 303
7523	186
7525	174
7526	158
7527	190, 303
7528	158
7529	159, 259
7530	159, 259
7531	341
7532	341
7533	341
7534	185
7535	185
7536	139
7537	141, 372
7538	183
7539	183
7540	183
7541	183
7542	115, 137
7543	184
7544	137
7545	137
7546	115
7547	142, 374
7548	136
7549	185, 303
7550	157, 302
7551	172
7552	175
7553	174
7554	175
7555	179
7556	177
7557	154
7558	141, 373
7559	115
7560	140
7561	182
7562	139
7563	140, 373
7564	140, 373
7565	143, 375
7566	124
7567	126
7568	126
7569	142, 191, 301
7570	137, 364
7571	97, 159, 259

7573	136
7599	138, 165
7600	164
7601	172
7602	173
7603	163, 342
7604	163, 343
7605	162
7606	164
7607	164
7608	161, 207
7609	161, 207
7610	180
7611	181
7612	181
7613	180
7614	175
7615	175
7616	145
7617	170
7618	191, 301
7619	104
7620	91
7621	90
7622	105
7623	91
7624	92
7625	103
7626	103
7627	105
7628	102
7629	93
7630	76
7631	77
7632	101
7633	100
7634	74
7635	108
7636	107
7637	98
7638	76
7639	72
7640	72
7641	71
7642	110
7643	91
7644	99
7645	99
7646	93
7647	93
7648	98
7649	99
7650	99
7651	110
7652	111
7653	111
7654	116
7655	116
7656	116
7657	116
7658	116
7659	116
7660	116
7661	116
7662	116
7663	116
7664	116
7665	116
7666	116
7667	116
7668	116
7669	116
7670	116
7671	116
7672	116
7673	116
7674	116
7675	116
7676	116
7677	116
7678	116
7679	116
7680	116
7681	116
7682	116
7683	116
7684	116
7685	116
7686	116
7687	116
7688	116
7689	116
7690	116
7691	116
7692	116
7693	116
7694	116
7695	116
7696	116
7697	116
7698	116
7699	116
7700	116
7701	116
7702	116
7703	116
7704	116
7705	116
7706	116
7707	116
7708	116
7709	116
7710	116
7711	116
7712	116
7713	116
7714	116
7715	116
7716	116
7717	116
7718	116
7719	116
7720	116
7721	116
7722	116
7723	116
7724	116
7725	116
7726	116
7727	116
7728	116
7729	116
7730	116
7731	116
7732	116
7733	116
7734	116
7735	116
7736	116
7737	116
7738	116
7739	116
7740	116
7741	116
7742	116
7743	116
7744	116
7745	116
7746	116
7747	116
7748	116
7749	116
7750	116
7751	116
7752	116
7753	116
7754	116
7755	116
7756	116
7757	116
7758	116
7759	116
7760	116
7761	116
7762	116
7763	116
7764	116
7765	116
7766	116
7767	116
7768	116
7769	116
7770	116
7771	116
7772	116
7773	116
7774	116
7775	116
7776	116
7777	116
7778	116
7779	116
7780	116
7781	116
7782	116
7783	116
7784	116
7785	116
7786	116
7787	116
7788	116
7789	116
7790	116
7791	116
7792	116
7793	116
7794	116
7795	116
7796	116
7797	116
7798	116
7799	116
7800	116
7801	116
7802	116
7803	116
7804	116
7805	116
7806	116
7807	116
7808	116
7809	116
7810	116
7811	116
7812	116
7813	116
7814	116
7815	116
7816	116
7817	116
7818	116
7819	116
7820	116
7821	116
7822	116
7823	116
7824	116
7825	116
7826	116
7827	116
7828	116
7829	116
7830	116
7831	116
7832	116
7833	116
7834	116
7835	116
7836	116
7837	116
7838	116
7839	116
7840	116
7841	116
7842	116
7843	116
7844	116
7845	116
7846	116
7847	116
7848	116
7849	116
7850	116
7851	116
7852	116
7853	116
7854	116
7855	116
7856	116
7857	116
7858	116
7859	116
7860	116
7861	116
7862	116
7863	116
7864	116
7865	116
7866	116
7867	116
7868	116
7869	116
7870	116
7871	116
7872	116
7873	116
7874	116
7875	116
7876	116
7877	116
7878	116
7879	116
7880	116
7881	116
7882	116
7883	116
7884	116
7885	116
7886	116
7887	116
7888	116
7889	116
7890	116
7891	116
7892	116
7893	116
7894	116
7895	116
7896	116
7897	116
7898	116
7899	116
7900	116
7901	116
7902	116
7903	116
7904	116
7905	116
7906	116
7907	116
7908	116
7909	116
7910	116
7911	116
7912	116
7913	116
7914	116
7915	116
7916	116
7917	116
7918	116
7919	116
7920	116
7921	116
7922	116
7923	116
7924	116
7925	116
7926	116
7927	116
7928	116
7929	116
7930	116
7931	116
7932	116
7933	116
7934	116
7935	



# ÍNDICE ALFABÉTICO / POR MODELO

MODEL REF. PG.

## A

ABEND	1302	383
ADAL	7544	137
ADARE	7175	154
ADAYA	3986	193, 306
AKALA	0100	285
AKEBIA	4008	198
ALANI	8073	110
ALAX	3030	19
ALBA	8050	109
ALBERO	3110	323
ALDAZ	7047	325
ALDER	8079	83
ALESSO	3210	28
ALETA	7531	341
ALFE	4037	217
ALGOR	4113	247
ALKE	4034	229
ALOE	4044	235
ALPINIA	4042	228
ALSEN	4142	281
ALTON	7991	72
ALVIK	7973	90
ALVOR	7975	91
AMAZONIA	8001	99
ANDROS	7988	107
ANFI	8057	114
ANGUS	4116	245
ANON	4015	202
ANSAR	8201	133, 370
ANTIX	3055	33, 61, 264
AOKI	3300	54
ARASHI	8048	84
ARAYA	8023	94, 275
ARCE	7538	183
ARCO	8054	111
ARDAK	8091	108
ARDEA	7552	175
ARDENES	8013	88
ARETA	3097	313, 331
ARIEL	8103	335
ARMIN	3204	48
ARNOLD	9935	135, 371
AROLA	9136	240
ARTUR	8044	72
ASTER	1038	261
ASTRO	3019	29, 59
ATHLETIC	4045	233, 305
AURA	7092	349
AZOR	7529	159, 259

## B

BADOC	3039	35, 59
BAGUETTE	7519	174
BAIKAL	5603	294
BAKAN	7998	93
BALAX	4122	220, 304
BALDER	7033	355
BALMOR	7198	144
BALOK	7985	100
BAOBAB	4049	233, 305
BARI	8105	333
BARNET	7166	187
BARONE	7085	152
BARU	4147	244
BASH	7070	329
BASICA	7000	314, 356
BATUM	0102	284
BAUME	8005	87
BAWEN	3057	44, 61
BAY	7103	314, 352

BEYONA	7086	162
BEISO	1225	365
BELLE	1231	363
BELOC	7015	318
BELONA	7612	181
BELUGA	4145	222
BELVER	4030	205
BEMOL	3193	34
BENDER	3350	57
BERING	5622	290
BERLIN	7196	173
BERNA	7156	169
BERRY	4012	200, 379
BESKY	8093	73, 88
BIKING	4047	236
BIKU	1229	269, 369
BINTAL	4096	279
BIOKO	4207	266
BISHOP	9906	368
BISMAR	7608	161, 207
BLEIK	7187	120
BLUES	3026	28, 53
BLUNT	1221	363
BOBIN	6999	337
BODEN	7125	188
BODONI	8041	73
BOINA	4039	225, 305
BONCER	4110	264
BONDY	7193	169
BOPP	3013	60, 132
BORA	0103	283
BORAN	4115	245
BOREAL	8000	98
BORNEO	8014	87
BOSCO	8063	113
BOST	9139	239
BRANDON	5624	290
BRANTA	8200	133, 370
BREMEN	7084	155
BRENA	4069	203
BRESCIA	7165	153
BREST	7087	152
BRICO	3991	272
BRILL	0107	275
BRISA	8100	335
BRISCA	1016	255
BROLY	4205	232
BUBO	7547	142, 374
BUDAN	4054	265
BULNES	6997	292
BURAK	3309	42, 53
BUREN	4130	165
BURTON	7995	91
BUSTAN	4062	201

## C

CALAO	7151	158
CALES	8072	107
CALESA	3111	323
CALISTO	7050	314, 356
CALON	1022	338
CALPE	7101	352
CALVIN	3202	49
CAMBRAI	7573	136
CAMU	4040	216, 306
CANAIMA	8004	87
CANARY	7121	147
CAPSUL	4132	209
CARDU	3995	253
CARIBU	7511	143, 371
CARNIVAL	3101	320

CAROL	1310	383
CARREL	8039	79, 377
CEDRO	4206	212
CELEB	3103	321
CELSIUS	3016	21
CENIX	1023	340
CHAKRA	7102	348
CHALA	4087	247
CHARRAN	7517	131
CHARTER	8204	135
CHELSY	8311	134
CHITO	4058	234
CHUCAO	7146	129
CIRO	8101	335
CITIX	8099	81
CITOS	1226	369
CITRUS	1314	262
CLIVE	9944	367
CLOUD	8110	303, 334
COAST	7543	184
COCO	4081	208
COIBA	4211	211
COLINA	7559	115
COLINS	4111	251
COLMER	4117	204
COLOMA	8017	77
COLUMBA	7120	146
COLUMBIA	1017	284
COMET	7013	318
COMPER	8043	83
COMTE	4102	246
CONDOR	7153	149
CONWI	8076	78
COPO	4059	222, 304
CORAL	8051	109
CORE	3024	31
CORK	7119	314, 352
COSTEN	3037	52
COUVET	8002	95
COVAS	2991	132, 371
COX	3200	49
CREST	7506	190
CROSSFITTER	9001	315, 353
CUANCA	7150	156
CUBIK	1041	257
CUSTIK	3310	41
CYLON	4187	68

## D

DAIKON	4103	204
DALBVIK	7046	325
DALBY	4202	210
DALIA	4107	206
DALIC	9322	350
DAMASCO	4014	202, 309
DAMPER	5600	294
DANERIS	5625	291
DANGO	4135	226
DANICA	8053	112
DANIEL	3994	253
DANTE	8096	81
DARIT	7977	103
DAVOS	7986	74
DAX	8102	334
DEAN	8065	116
DELPHIS	7536	139
DELUN	9947	293
DEMAR	1025	287
DEMAR	3038	40
DENIA	7096	336
DENOK	7997	99

DEVON	4114	245
DEXTER	7567	126
DILBAR	3356	38
DIMAS	8062	114
DINTEL	3983	274
DISCOVERY	2100	56
DODO	7138	130
DOEL	7537	141, 372
DOKI	4209	326
DOMIS	1013	255
DONA	1232	269, 369
DONET	7126	190
DORMITUR	8012	85
DOVEL	1026	274
DOVER	8095	87
DRACO	3401	55
DRAVIS	2989	14
DRILO	3094	324
DROIDE	3354	56
DROP	1222	369
DUCASSE	9129	242, 315
DUKE	7171	128
DUMAI	1216	364
DUNCER	3043	22
DUNE	7525	174
DUSK	7060	318

## E

ECOHOST	7055	328
EDAM	4101	246
EDDO	4041	235
EDEN	8104	334
EIDER	8202	340
ELANIO	7528	158
ELION	8061	109, 376
ELSON	3311	39
ELVIS	7049	313, 330
EMON	7097	347
ENEKO	9137	243
ERIS	7019	359
ESTELA	8070	110

## F

FALCO	7115	146
FALCON	3005	58
FANCY	4126	223, 304
FARBER	8022	79, 376
FARGO	5611	297, 310
FENGI	4035	213
FENIX	8020	117
FEROE	1003	338
FERA	3305	53
FESTERO	9003	320
FETE	3102	324
FIDES	7009	358
FIRENZA	7179	145
FLAG	4080	268
FLAKE	1306	380
FLASH	0110	275
FLAY	7164	179
FLINT	8066	116
FOCHA	7523	186
FOLK	3045	16
FORSET	9144	241
FRANKLIN	9921	273
FRESH	9923	366
FREYA	7030	357
FROST	7082	248
FROSTY	6998	292
FUNK	3307	52

## G

GALA	8082	106
------	------	-----

GALAXY	7063	319
GALVY	1014	254
GAMMA	3027	32
GANDA	7069	329
GANTE	5627	282
GARNAX	4118	249
GARNES	7178	122
GARO	8085	113
GARRIX	3201	49
GARZA	7518	131
GASLY	3036	29
GAURA	1039	261
GAVIA	7099	177
GELDA	4204	232
GENZEL	9934	368
GILDON	8080	75
GILMAN	9907	368
GIRAX	1036	260
GLAZE	1220	363
GLEN	8067	116, 258
GLORY	5626	289
GOLIAT	3990	276
GORBEA	8028	78
GORDON	3014	60, 132
GOSPEK	3034	45
GOSTO	4064	201
GRACE	7610	180
GRAJA	7604	163, 343
GRAVITY	3022	32
GREGOR	7139	124
GRETA	7167	168
GROVE	8029	83
GRULLA	7605	162
GRYFIN	8046	95, 376
GUAYA	4082	203
GUDAR	4191	67
GUEST	7054	327

## H

HAL	3353	57
HALE	0109	275
HALLERBOS	8015	89, 377
HALLEY	7062	319
HAMELIN	7114	157, 302
HANA	8032	82
HARDWELL	3207	28
HARUL	5609	296, 310
HAYA	7539	183
HAYEDO	8030	88
HELDENS	3209	37
HERA	8068	116
HIBIS	4053	265
HILL	7601	172
HILLOCK	7520	172
HINDRES	8045	80
HORUS	8059	116
HOST	7053	328
HYDRA	3054	60

## I

IBERIS	7023	355
ICARUS	3029	23
INCA	7189	171
INDAL	3998	208
INNIS	8056	114
IRATI	8011	85
IRIS	8071	107
IROKO	4138	210

## J

JACK	4010	198
JAMBOREE	3106	321
JAMIE	9133	242

JERRY	3052	65
JINGLE	1305	382
JONES	7018	318

## K

KAFFIR	4060	195, 306
KAGU	7155	157
KAIDE	3988	276
KALAY	8150	337
KALE	4105	224
KALMAR	7500	124
KAMUT	8035	80
KANCHAN	8024	94
KANDA	7180	155, 191, 301
KARIN	7026	354
KASPER	3050	65
KASTER	4098	216, 306
KEBAL	7566	124
KELLER	9130	242
KELSEY	7057	314, 352
KELVIN	3004	21
KEMER	7600	164
KEMY	4149	219
KENDAL	4124	313, 330
KENSAL	7168	168
KEROS	3114	323
KEVES	2994	18
KHASI	5610	299, 311
KIMEX	7195	166
KIMI	1311	263, 381
KINATA	4032	212
KING	1307	263, 380
KINI	0101	285
KINKAN	4038	235
KINOX	4193	66
KINTO	4121	339
KIANTO	8036	73
KISKO	4213	231
KIWAN	4083	202
K		

MODEL REF. PAG.

LEAF	7553	174
LEBAC	2993	19
LEDES	4197	67
LEDO	7978	103
LEGRAND	3150	50
LEIS	0111	257
LEMON	3999	194, 307
LEVY	7014	317
LEWIK	4212	230
LEYNAX	7994	110
LIANDE	8042	83
LIBE	7516	131
LIEN	8074	111
LIKA	8025	78
LILIAN	8047	258
LIMA	4000	194, 307
LIMOSA	7545	137
LINER	1223	363
LISSEN	1124	365
LIZANA	8064	97
LOCK	0108	272
LOIRE	7613	180
LOMBAS	7599	138, 165
LOMBOK	7089	161, 343
LORA	7515	130
LUANDA	7091	153
LUBIN	7197	160, 342
LUMIA	7617	170
LYRA	3010	33, 61, 264
LYSE	5607	297, 310
<b>M</b>		
MABEL	8089	99
MACHA	3997	196
MACK	1007	283
MAFIL	7190	167
MAGUN	4144	221, 305
MAKA	1312	263, 380
MALBEC	4112	249
MALMO	7106	125
MALOW	4077	205
MALT	4074	266
MANATI	7533	341
MANDY	4086	237
MANGO	4001	195, 309
MAPLE	7541	183
MARABU	7124	150
MARANG	4084	194, 307
MARATHON	7118	351
MARBEL	4109	265
MARCO	3211	17
MARDOK	7173	129
MARLOX	7609	161, 207
MARS	3021	37
MARSAL	2990	20
MARVIN	4186	68
MATA	8003	95, 273
MAULE	9140	239
MAURO	9138	241
MAUVE	7570	137, 364
MEDEA	7542	115, 137
MEDUS	1002	117
MEDY	1227	369
MELBUX	2995	45
MERCURY	7020	314, 354
MERLIN	8009	78
MERLOT	4075	249
MESLER	9946	367
MILANA	7607	164
MILANO	7526	158
MILFORD	5608	297, 310

MILOS	3112	322
MILU	4029	227
MILVUS	7561	182
MINERAL	4051	268
MIRLO	7137	154
MISO	7618	191, 301
MISTY	3349	30
MISURI	7181	149
MITO	7527	190, 303
MIYAGI	5605	298, 311
MOANA	7172	127
MOKE	7081	248
MONDELO	7616	145
MONJE	7532	341
MOON	3197	26
MOUNTAIN	7602	173
MUNA	7098	152
MUNTOK	1024	287
MURDOK	4120	278
MURET	7981	93
<b>N</b>		
NAGAMI	4055	215
NAGOYA	8084	75
NAIPE	1028	255
NAMUR	3044	13
NANTES	7110	176
NANUK	9004	293
NAPA	7614	175
NARBONA	7159	168
NARO	7497	138, 372
NARVIK	7177	126
NASKA	7090	154
NAURO	5999	298, 311
NEBULA	3001	31
NELA	7044	327
NEPTUNE	3023	30, 59
NERVO	3306	28
NETIX	4198	67
NEWTON	8038	79, 377
NICK	1309	384
NIMBA	7611	181
NIMES	7149	178
NINFA	7152	156, 302
NISEK	4128	281
NIZA	7160	173
NOBEL	9919	368
NOEL	1301	384
NOLO	4009	198
NOPAL	9142	240
NORA	3405	55
NORBY	3035	43
NORFLOK	8078	88
NORI	4146	244
NOSOK	4143	281
NOVAK	7170	145
NOYS	8199	133, 370
NUKKA	2009	293
NUSS	1303	365
<b>O</b>		
OBLAK	7182	147, 371
OCEAN	7501	189
OKELE	4134	227
OKRA	4085	195, 309
OLIVER	9135	241
OLMO	7122	182
OLTEN	7990	76
OLYMPIA	7104	315, 353
ONTARIO	8008	82
ORBIT	3098	324
ORCA	7535	185

ORLY	7100	336
ORMOK	7568	126
OSAK	7569	142, 191, 301
OSAKA	5998	296
OTAWA	7183	148
OZCAN	3195	27
<b>P</b>		
PACHU	9131	159, 259
PACIFIC	8033	84
PALE	4073	267
PALMER	4106	226
PALMIRA	7188	171
PALTA	4007	199
PAMPA	8019	74
PANA	4097	213
PANEL	7008	359
PANTALA	7549	185, 303
PAPAYA	4006	199
PARADIS	3096	313, 331
PARCHA	4063	201
PARDELA	7513	143, 375
PARMA	7163	179
PARTY	3100	324
PENSY	1035	256
PENTA	7982	76
PERCY	4189	66
PETRA	8206	135
PEYOT	9143	240
PHOCA	7534	185
PIANA	7987	108
PICK	0106	274
PINEA	4140	247
PINUS	7123	182
PIRGO	7983	77
PITA	4011	229
PLANET	9009	292
PLERION	3033	59
PODOX	1126	134, 361
POLE	9924	367
POMEL	7045	329
PONTAL	4210	325
PRADO	7499	374
PRISMA	1008	285
PROMET	3032	18
PUKET	4148	193, 306
PUNK	3301	54
PYRUS	8077	96
<b>R</b>		
RABIL	3028	244
RAKU	7185	176
RAMBU	4003	194, 307
RAMSAY	9128	242
RAYEL	3151	50
REGINA	7093	346
REMO	7562	139
REMY	3049	64
RENKO	4214	231
RENO	1308	385
RESOL	8069	96, 258
REVEL	3105	321
REYDON	7993	71
RIFTER	7169	280
RIGAX	4131	165
RINDAL	1316	263, 280
RIOT	4192	68
RIVER	7502	189
RIVET	0105	274
RIVOLI	7162	170
RIZO	1215	362
ROBBIE	3352	57

ROBIN	8081	106
ROBLE	7540	183
ROCA	9132	243
ROCKS	1009	256
ROCKY	7094	346
RODEN	4090	251
ROGER	9134	243, 315
ROBO	3992	197
ROOMER	7052	328
ROSELLA	4013	200
ROSKO	0112	257
ROSSUM	3355	29, 57
ROY	4188	68
RUDDOLF	1299	383
RUNNING	4046	236
RYMAN	1010	256
<b>S</b>		
SACHA	4057	200
SAGANO	8031	78
SAGRA	8086	113
SAKRA	7088	160, 343
SAKURA	3191	47
SALAK	4028	227
SALER	8055	112
SALVIA	4123	226, 304
SAMAR	7984	101
SAMBAL	4061	206
SAMUI	3987	193, 308
SANDI	4099	217
SANDUR	8098	86
SANTA	1300	384
SAOKO	4203	214
SAONA	2150	338
SEA	7504-M13	189
SEDNA	7565	143, 375
SELBY	4200	228, 305
SELKIS	8083	116
SEMENIC	8006	85
SERBAL	3017	117
SERPA	7191	167
SERRETA	7606	164
SEYKU	1228	269, 369
SHAKA	5601	295
SHAKE	4078	251
SHERLOCK	0104	273
SHERRY	4088	251
SHIRA	1019	286
SIBON	2988	35
SIBU	4137	215
SIDNEY	7176	125
SIENA	7564	140, 373
SIERRA	7558	141, 373
SIKAS	7971	104
SILA	4092	265
SILVANO	3012	63, 312
SIMBA	1018	286
SIMON	7972	91
SINATRA	7071	313, 331
SIRA	3011	63, 312
SIRIO	5063	282
SISON	7154	149, 302
SITO	4079	268
SKYE	1006	337
SOIL	7554	175
SOLAZ	7571	97, 159, 259
SOLUM	3199	27
SONIC	2998	62, 312
SORBY	3984	271
SOTOS	4100	213
SOYER	7979	105

SOYUZ	3018	29, 58
SPARKLING	4070	266
SPEED	7105	315, 351
SPRING	3095	313, 331
STARK	8040	80, 377
STELO	4094	264
STERNA	7555	179
STEVE	3208	37
STIX	8010	80
STOA	8034	75
STOUT	4071	266
STRICKLAND	9939	261
STUART	3051	67
SULAC	3031	17
SUMBA	7043	326
SUN	7061	319
SUPPORT	3109	321
SURNA	1313	262, 379
SUVER	7992	72
SYRAH	4076	249
<b>T</b>		
TABER	9141	240
TABOR	7068	329
TACET	3040	51
TAKAY	3194	34
TANGO	3042	34
TARDIS	3000	60
TAREK	4125	228
TARVOS	7024	358
TAYOX	4056	224
TEIDE	3985	203
TENOR	3192	41
TEROS	7145	150
TERRA	7012	359
TIBU	7603	163, 342
TIKUN	7999	93
TILOS	8049	96, 258
TINSEL	1298	382
TINTOS	4129	250
TISET	4201	225
TOCO	7522	186, 303
TONIC	4050	267
TORKE	4139	223, 304
TRACK	4119	237
TRAIL	4104	237
TRAP	3025	52
TRENTO	7127	190, 303
TRESNA	1004	268
TREVEL	7128	187
TRILBY	4020	214
TRIWA	1011	256
TUCAN	7158	151
TUCHEL	2151	350
TUCUMA	8018	74
TULSY	1037	260
TURCAZ	7530	159, 259
TURIN	7976	92
TURNER	4127	271
TYTO	7560	140
<b>U</b>		
ULDON	4190	66
UMEK	3196	46
URANUS	7041	358
<b>V</b>		
VALDI	3312	39
VALLE	8052	111
VALMIR	7194	166
VALSAN	4067	234
VANDIKO	3203	48
VANILA	1315	262, 379

VARESE	7107	153, 170
VARMUS	9908	368
VATOX	2996	44, 58
VELVET	1125	134, 361
VENAK	4194	66
VENET	4091	250
VENICE	7161	177, 342
VERA	7563	140, 373
VERNAK	8087	97
VERTUS	4133	208
VESPULA	7546	115
VETA	8088	95, 273
VIBO	4196	66
VIDUR	3989	276
VIKEN	4195	67
VIZA	1040	254
VOLANO	7186	119
VOLEN	1000	261
VOLGA	7147	184
VOSTOK	5602	295
VULCAN	7095	345
VULCO	2992	22
VULTUR	7548	136
<b>W</b>		
WALAX	3996	196
WALDO	8092	98
WALKER	4141	253
WARKA	7083	123
WATSON	8060	109, 376
WAVE	7556	177
WILDE	7174	151
WILKES	7557	154
WILLMAN	3402	55
WIZER	7048	314, 353
<b>Y</b>		
YABA	4033	213
YACA	4004	233
YAKU	5606	299, 311
YAMA	8021	77
YAMBI	7989	98
YARBO	2987	15
YASPER	7980	102
YATE	4108	265
YISEL	4093	218
YLLIER	8151	133, 370
YOBO	4065	201
YUBA	2997	62, 312
YUBARTA	7514	143, 375
YUCA	4005	199
YUMA	3093	351
<b>Z</b>		
ZALA	4024	197, 381
ZANTE	3113	322
ZAPAX	7615	175
ZATOX	3308	42
ZELAND	5623	293
ZENITH	7551	172
ZIBAL	2999	38
ZIGARI	749	

# ÍNDICE POR PRODUCTO / FAMILIA

A	
Abanicos	322, 323
Abridores	249, 251, 267
Adaptadores de corriente	60, 132
Adornos de navidad	136, 137
Agendas	116
Alarma personal	371, 132
Alfombrilla calendario	117
Alfombrilla cargador	19, 40
Alfombrilla de escritorio	62, 312
Alfombrilla de ratón	19, 62, 63, 312
Almohadillas de viaje	370, 133
Altavoces inalámbricos	17, 26, 27, 28, 34, 37, 39, 41, 42, 44, 46, 47, 48, 49
Altavoz cargador	37, 41, 42, 47
Ambientador	280
Anti estrés	269, 369
Aplaudidores	321
Auriculares	16, 25, 28, 39, 42, 43, 50, 51, 52, 53, 54
Auriculares inalámbricos	16, 25, 28, 39, 42, 43, 50, 51, 52, 53
B	
Balón	350
Balón hinchable	338
Bálsamos	365
Banderines	321
Baraja de cartas	255
Báscula digital	244
Bastoms	305
Bastones	345
Batería Externa Inalámbrica	29, 30, 38, 57
Batería Externa Solar	56
Baterías Externas	29, 30, 38, 56, 57
Bidones	211, 213, 214, 215, 216, 217, 219, 220, 221, 222, 223, 224, 225, 228, 229, 230, 231, 232, 233, 234, 235, 236, 237, 304, 305, 306
Bidones de cristal	214, 215, 216, 217, 306
Bidones para sublimación	223, 228, 304, 305
Bidones termo	211, 219, 220, 222, 223
Bloc de notas	103, 104, 105, 106, 107, 108, 109, 110
Bloc de notas Anti bacterias	109, 376
Bloc de notas papel semillas	113
Bloc de notas soporte	103
Bolígrafo linterna	94, 275
Bolígrafo marcador	84
Bolígrafo multicolor	86
Bolígrafo multiherramienta	94, 272
Bolígrafo spray	79, 376
Bolígrafos	72, 73, 74, 75, 76, 78, 79, 80, 81, 82, 83, 84, 85, 86, 87, 88, 89, 90, 91, 94

Bolígrafos Anti bacterias	79, 89, 377
Bolígrafos con puntero	74, 85, 86, 87, 89
Bolsa Colorear	259, 159
Bolsa mochila	170
Bolsa nevera	342, 160, 177
Bolsas	301, 303, 166, 167, 168, 169, 170, 171, 172, 173, 174, 175, 176, 177, 178, 179, 180, 181, 182, 183, 184, 185, 187, 188, 189
Bolsas algodón	166, 168, 169, 170, 171, 172, 173, 174, 175
Bolsas de cáñamo	167
Bolsas de papel	182, 183
Bolsas de yute	176, 177, 178, 179, 180, 181
Bolsas estancas	341
Bolsas Fairtrade	166
Bolsas para sublimación	301, 303, 190, 191
Bolsas plegables	176, 186
Bolsas RPET	185
Bolsos multifunción	144, 145, 173
Bowl plegable	287
Braga Gorro	293
Bragas polares	293
C	
Calcetines de navidad	138
Calendarios	116
Calendarios perpetuos	117
Cámara deportiva	56
Cargador soporte	32, 37
Cargador USB de coche	60
Cargadores inalámbricos	15, 17, 29, 31, 32, 35, 37, 38, 44, 58
Cargadores Llaveros 3 en 1	29, 59
Carpeta multihusos	100, 101, 102
Cenicero de bolsillo	340
Cepillo con espejo	363
Cepillos de dientes	366, 367
Ceras de colores	98
Chaleco	282
Chanclas	337
Cinta deportiva	353
Cinta para sombrero	302
Cinturón multifunción	351
Coctelera	253
Collar de mascotas	286
Combas	346
Cubo	339
Cubre volante	283
Cuchara	244
Cutters	272

D	
Delantal para colorear	259, 159
Delantales	239, 240, 241, 242, 315
Dispensador de bolsas	286
Dominó	255
E	
Enfriador de botellas	248
Escalímetro	274
Espátula	244
Espejos	363
Estación meteorológica	21
Esterilla de yoga	348, 349
Estuche para colorear	259, 159
Estuches	97, 115
F	
Fiambreras	201, 203, 204, 206
Flexómetros	274
Frisbee	287, 338
Funda de gafas	303, 334
Funda para bolígrafos	91
Funda para jamón	187
Funda para ordenador	126
G	
Gafas de seguridad	273
Gafas de sol	333, 334, 335
Geles hidroalcohólicos	368
Gorras	314, 354, 355, 356, 357, 358, 359
Gorro	292, 337
Gorro de navidad	138
Gorro reversible	292
Guante táctil	293
H	
Humificador	262
I	
Identificador de maletas	135
Identificadores	329
Imán Portanotas	258
J	
Jarra Sublimación	193, 306, 308
Juego de bolos	254
Juegos de habilidad	254, 256, 257
L	
Lámpara	14, 20, 26
Lámpara despertador	13
Landyards	313, 325, 326, 327, 328, 330
Lanyards Sublimación	313, 330



Lápices	95, 273, 376
Lápices de colores	99
Lápiz de carpintero	95, 273
Lápiz de navidad	139
Lápiz infinito	92, 93
Libreta papel semillas	113
Libretas	106, 110, 111, 112
Linternas	275
Llavero flexómetro	268
Llaveros	265, 266, 267, 268, 326
Lupa cuentahilos	273
<b>M</b>	
Maceta	260, 261
Manopla	241, 243
Manopla sublimación	243, 315
Manta térmica	282
Mantas	289, 290, 291
Mantel individual	240
Máscara facial	133
Memorias USB	66, 67, 68
Mini Libreta	111
Mochila antirrobo	127
Mochila de cáñamo	154
Mochila Fairtrade	152
Mochila multicolor	155
Mochila nevera	343, 160, 161, 163
Mochila para colorear	259, 159
Mochila reflectante	155
Mochila sublimación	301, 302, 155, 191
Mochilas	302, 123, 124, 125, 125, 126, 127, 128, 129, 130, 145, 146, 147, 148, 149, 150, 151
Mochilas algodón	145, 152, 153, 154, 155
Mochilas de cuerdas	302, 152, 153, 156, 157, 158, 159
Monederos	364, 137
multiherramientas	271, 272, 278
Muñequera	315, 351
<b>N</b>	
Navajas multiusos	277, 279
Neceser de cáñamo	138
Neceser Fairtrade	138, 139
Neceser sublimación	301, 191
Neceseres	301, 371, 372, 373, 374, 375, 134, 138, 139, 140, 141, 142, 143
Neveras	207, 342, 161, 162, 163, 164
<b>O</b>	
Organizador cargador	31
Organizador de maletero	280

<b>P</b>	
Pajitas	205
Palas de playa	338
Paño de cocina	240
Pañoletas	320
Paraguas	296, 297, 298, 310
Paraguas plegables	298, 299, 311
Paraguas Sublimación	310, 311
parasoles	283, 284, 285
pastilleros	369
Peine	362, 364
Pelota	287
Petaca	253
Peto deportivo	320, 350
Pizarra magnética	258
Ponchos impermeables	294, 295
Porta notas adhesivas	113, 114
Portabocadillos	165
Portadocumentos	124, 130, 131
Portafotos cargador	18, 22
Portalápices	18, 45
Portamascarillas	371
Portatodo	340
Posavasos	247
Puerto USB	30, 35, 45
Pulsera reflectante	351
Pulseras	313, 324, 331
Pulseras sublimación	313, 331
<b>R</b>	
Rascador de hielo	281
Ratones inalámbricos	64, 65
Reloj cargador	22, 23
Relojes Inteligentes	55
Riñoneras	136
Rollers	72, 77
<b>S</b>	
Sacacorchos	
Set adornos de navidad	
Set Bandas Elásticas	
Set bolsas reciclaje	
Set cepillo de dientes	
Set de cocktails	
Set de cubiertos	
Set de herramientas	
Set de juegos	
Set de manicura	

Set de vino	
Set Escritura	
Set infantil de pintar	
Set limpieza calzado	
Set para quesos	
Set Roller y portaminas	
Silbato	
Sombreros	
Sombrilla de playa	
Soporte para Smartphone	
<b>T</b>	
Tabla de cortar	245
Tangram	257
Tapa webcam	65
Tapones de oídos	370, 133
Tazas	194, 195, 196, 197, 198, 199, 200, 201, 202, 203, 208, 306, 307, 308, 309, 379
Tazas para sublimación	194, 195, 202, 306, 307, 308, 309
Termo multiusos	226
Termos	212, 213, 224, 226, 305
Tizas de colores	98
Toalla Pareo	336
Toallas	314, 336, 352
Toallita higienizante	368
Trolley	122
Trolley maleta	119, 120
<b>U</b>	
USB HUB	30, 35, 45
<b>V</b>	
Vaso medidor	253
Vaso sublimación	193, 306
Vaso termo	227
Vasos	193, 200, 201, 208, 209, 210, 213, 227, 236, 306, 325
Velas	262, 263
Visera	314, 353
<b>Y</b>	
Yoyó	257
<b>Z</b>	
Zapatillas	370, 133
Zapatillero	371, 147

# CÓDIGOS DE COLOR

COLOR	CÓDIGO
Aguamarina	236
Amarillo	03
Amarillo Cañamo	36
Amarillo Flúor	221
Amarillo Flúor Vigoré	249
Amarillo Golden	96
Amarillo Maiz	163
Angora	229
Árbol	512
Arena	07
Arena Oscura	219
Azul Dénim	86
Azul Dénim Vigoré	255
Azul Eléctrico	99
Azul Lab	44
Azul Lavado	126
Azul Luz de Luna	45
Azul Marino	55
Azul Marino Vigoré	247
Azul Niágara	43
Azul Océano	100
Azul Profundo	43
Azul Riviera	261
Azulina	65
Baloncesto	991
Bambú	999
Blanco	01
Blanco Perla	011
Blanco Vigoré	013
Borgoña	64
Borgoña Vigoré	238
Camel	85
Cebra	995
Celeste	10

COLOR	CÓDIGO
Chocolate	87
Copo	514
Coral flúor	234
Coral Flúor Vigoré	244
Crudo	29
Ébano	231
Ébano Vigoré	237
Estrella	511
Frambuesa	72
Francia	158
Fresa	84
Fucsia	40
Futbol	992
Granate	57
Granate Vigoré	256
Gris Vigoré	58
Gris Claro Vigoré	259
Gris Oscuro	59
Italia	161
Jirafa	997
Kiwi	990
Lima	225
Lima Limón	118
Lima Punch	235
Lima Vigoré	250
Limón	985
Manzana	986
Marrón	450
Morado	63
Morado Vigoré	253
Mostaza	30
Mostaza Vigoré	39
Naranja	31
Naranja Bermellón	311

COLOR	CÓDIGO
Naranja Flúor	223
Naranja Vigoré	310
Negro	02
Negro Vigoré	243
Noel	515
Nogal	67
Nude	165
Oro	260
Rosa Dorado	281
Orquidea	230
Ovalado	983
Pez	998
Piña	989
Pistacho	28
Plata	251
Plomo	23
Plomo Oscuro	46
Pollo	996
Portugal	162
Púrpura	71
Rectangular	981
Reno	513
Rojo	60
Rojo Crisantemo	262
Rojo Vigoré	245
Rojo Vino	116
Rosa Chicle	34
Rosa Claro	48
Rosa Flúor	228
Rosa lady Flúor	125
Rosetón	78
Rosetón Vigoré	252
Redondo	982
Royal	05

COLOR	CÓDIGO
Royal Vigoré	248
Sandía	984
Muñeco de nieve	516
España	157
Tenis	993
Tomate	987
Turquesa	12
Turquesa Vigoré	246
Uva	988
Verde Botella	56
Verde Botella Vigoré	257
Verde Flúor	222
Verde Grass	83
Verde Helecho	226
Verde Helecho Vigoré	135
Verde Irish	24
Verde Jungla	217
Verde Kaki	13
Verde Kelly	20
Verde Lab	17
Verde Mantis	69
Verde Mantis Vigoré	693
Verde Marea	041
Verde Menta	98
Verde Menta Vigoré	980
Verde Militar	15
Verde Militar Oscuro	38
Verde Militar Vigoré	153
Verde Mist	264
Verde Oasis	114
Verde Salvia	271
Verde Senda	124
Verde Tropical	216
Madera	88

# ICONOGRAFÍA

 CAJA	 PACK	 MEDIDAS	 TÉCNICAS DE IMPRESIÓN	 MADE TO ORDER
 BAMBÚ	 PET RECICLADO	 GPS	 NOTIFICACIONES DE MENSAJES	 COMPARTIMENTO PARA TABLET
 YUTE NATURAL	 ALU ALUMINIO RECICLADO	 HORA	 NOTIFICACIONES DE APP	 COMPARTIMENTO PARA ORDENADOR
 ALGODÓN ORGÁNICO	 CARTÓN RECICLADO	 APP	 GRABACIÓN DE ARCHIVOS	 IMPERMEABLE
 MADERA NATURAL	 FUNCIÓN ALTAVOZ	 4K 4K ULTRA HD	 TRANSFERENCIA DE DATOS	 RESISTENTE AL AGUA
 CORCHO NATURAL	 CARGA INALÁMBRICA	 TÁCTIL	 GRABACIÓN DE POSICIÓN	 RESISTENCIA AL VIENTO
 CEMENTO	 RADIO INTEGRADA	 LÁPIZ TÁCTIL	 HUMEDAD	 LIBRE DE BPA
 PLA	 WIFI	 MICRO SD	 TEMPERATURA	 ANTI PILLING
 TRITAN	 SONIDO ESTEREO	 MICRO SIM	 PULSÓMETRO	 REFLECTANTE
 ANTIBACTERIAL ISO 22196	 BLUETOOTH	 CARGADOR	 PRESIÓN DE SANGRE	 REVERSIBLE
 FIBRA DE TRIGO	 MANOS LIBRES	 CARGADOR RÁPIDO	 PRESIÓN DE OXÍGENO	 DOBLE PARED
 FIBRA DE BAMBÚ	 CRONÓMETRO	 ALARMA	 RFID	 LÍNEA DE ENTRADA
 BO CRISTAL DE BOROSILICATO	 LLAMADAS TELEFÓNICAS	 LUZ	 CONTADOR DE CALORÍAS	 LIGHTNING
 CÁÑAMO	 REPRODUCTOR DE MÚSICA	 COB LED	 CONTADOR DE PASO	 USB
 ALGODÓN RECICLADO	 CALCULADORA	 LUZ INTERMITENTE	 CONTROL DE SUEÑO	 USB TIPO C
 PAPEL RECICLADO	 GRABADORA DE SONIDO	 LUZ DE COLOR CAMBIANTE	 CIERRE DE SEGURIDAD	 MICRO USB
 ABS ABS RECICLADO (RABS)	 HORA & FECHA	 VIBRACIÓN	 BOLSILLO PARA BOTELLA	 ALGODÓN DE COMERCIO JUSTO



# TÉCNICAS DE MARCAJE



**Serigrafía**



**Sublimación**



**Sublimación tazas**



**Bordado**



**Transfers**

Código de marcaje	Técnica
A - K	Tampografía - Serigrafía
M	Cuatricomía
N	Transfer serigráfico
O	Transfer digital
Q	Sublimación tazas
R	Sublimación
T	Termo grabado
U	Termo grabado con cinta color
W	Impresión digital
P	Bordado
L	Láser

\*Nos reservamos el derecho a modificar sin notificación previa los códigos de impresión y/o número de colores publicados en este catálogo.



**Termograbado**

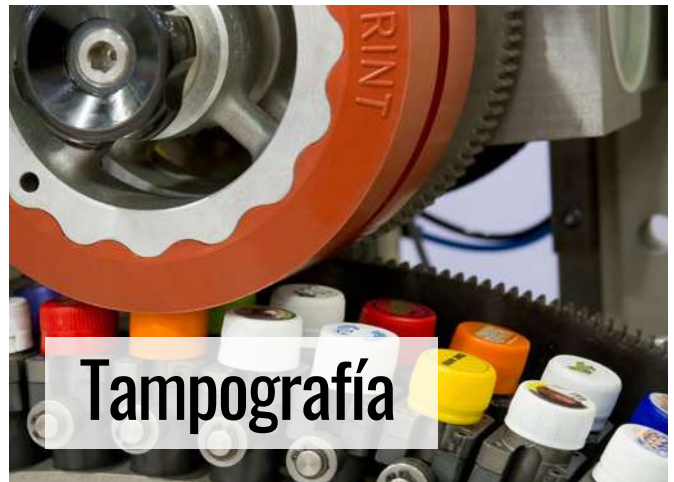

**Tampografía**



**Manipulado**



**Láser**



**Impresión digital sobre vinilo**

**AN  
UNLIMITED  
PROMOTIONAL  
WORLD**







# **Stamina**

POWER IDEAS

**PROMOTIONAL GIFTS**